



+

WINDOW
AND DOOR
FITTINGS

HOPO (USA) Inc.
Shenzhen HOPO Window Control Technology Co., Ltd

TEL: (+86) 755 27183199 FAX: (+86) 755 86611663
E-mail: sales@hopo.us Web: www.hopo.us

2021
NO.2021.01

SUPPLIER OF CONTROL SYSTEM
FOR WINDOWS AND DOORS

HOPO[®]
— ESSENTIAL —

REDEFINE WINDOW
OPENING



CHANGING THE TRADITIONAL OPENING SOLUTIONS THROUGH INNOVATIVE
HARDWARE CREATED
BY USING SCIENTIFIC FUNCTIONAL DESIGN FOR WINDOWS AND DOORS



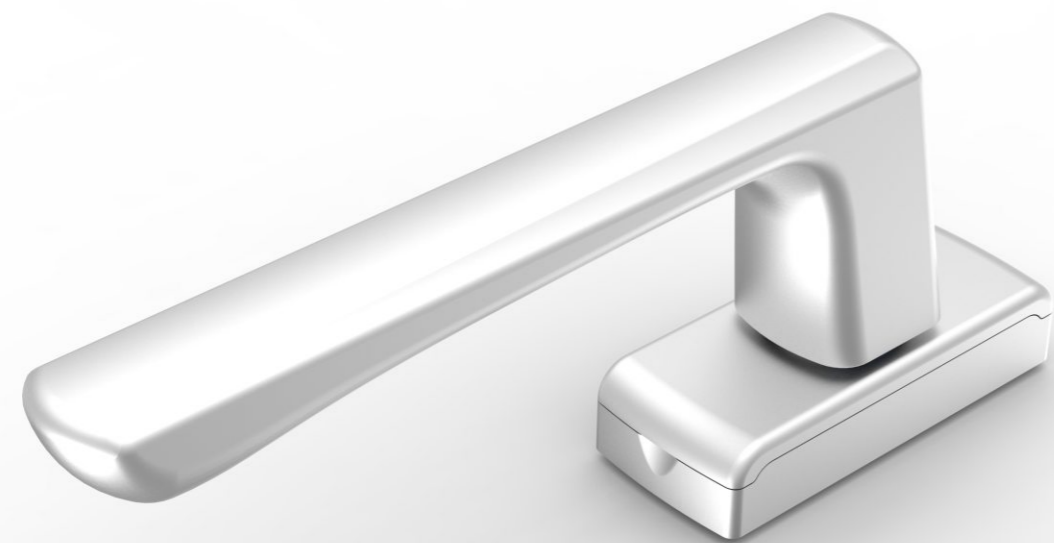

“Clicking” Handle

The clicking handle series with a metal mechanism in its rosette will create a pleasant sound when turning. The sound emitted by the inner stainless-steel mechanism will make opening and closing windows a charming and joyful experience.

WINDOW AND DOOR



Spindle handle PH903

Article No:PH903.00.XX
 Description: PH903Handle_Without spindle_Color
 Spindle length:Optional
 Surface treatment:Anodized/Power coating
 Application:Casement window
 (inward and outward opening handle)
 Packing:1pc/bag, 2bag/box, 15box/carton

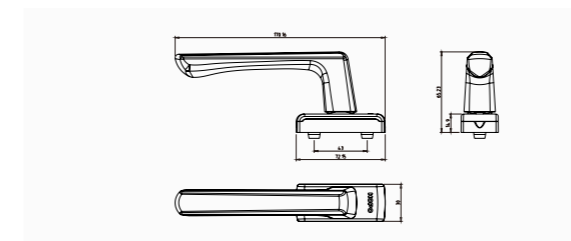

Spindle handle PH914

Article No:PH914.**.##H5
 Description: PH914Handle_Spindle length_Color
 Spindle length:**Customized
 Surface treatment:Anodized
 Application:Casement window
 (inward and outward opening handle)
 Packing:4pc/box, 15box/carton

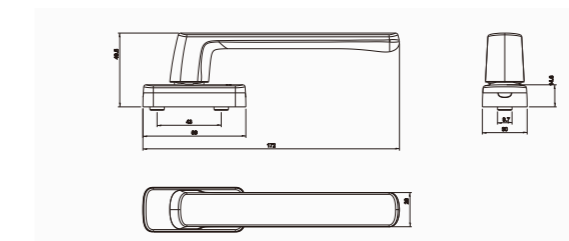

Spindle handle PH904

Article No:PH904.00.XXL/R
 Description: PH904Handle_Without spindle_Color_
 Left/Right
 Spindle length:Optional
 Surface treatment:Anodized/Power coating
 Application:Double sash window
 Packing:1pc/bag, 2bag/box, 15box/carton

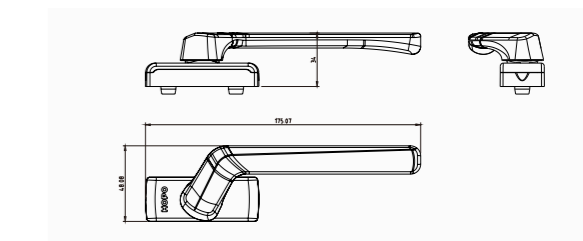



Spindle handle PH108

Article No:PH108.**.##
 Description:PH108Handle_Spindle length_Color
 Spindle length:Customized
 Surface treatment:Anodized/Power coating
 Application:Casement doors and windows/sliding doors
 Packing:1pc/bag, 10bag/box, 5box/carton

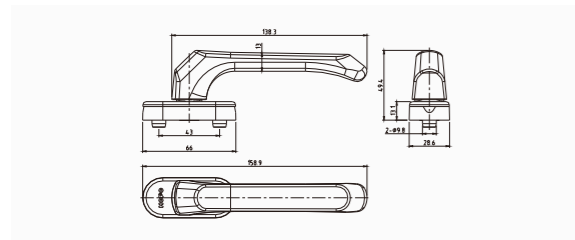

Spindle handle PH171 Stock

Article No:PH171.00.##
 Description:PH171Handle_Spindle length_color
 Spindle length:Without spindle, match SP07 spindle
 Surface treatment:Customized
 Application:Folding doors or double sash windows
 Packing:1pc/bag, 5bag/box, 8box/carton

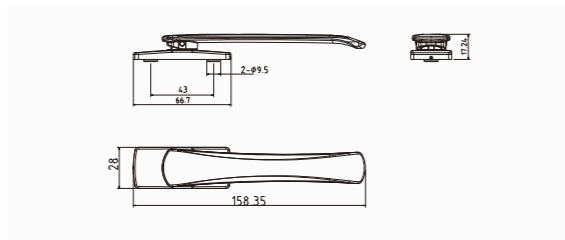

Spindle handle PH103

Article No:PH103.**.##L/R
 Description:PH103Handle_Spindle length_Color_Left/Right
 Spindle length:Customized
 Surface treatment:Anodized/Power coating
 Application:Outward side-hung door
 Packing:1pc/bag, 4bag/box, 15box/carton

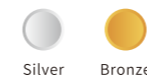
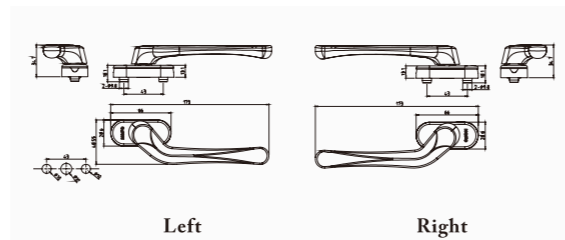

Spindle handle PH901

Article No:PH901.**.##
 Description:PH901Handle_Spindle length_Color
 Spindle length:Customized
 Surface treatment:Anodized
 Application:Casement window/sliding doors
 Packing:1pc/bag, 1bag/box, 20box/carton

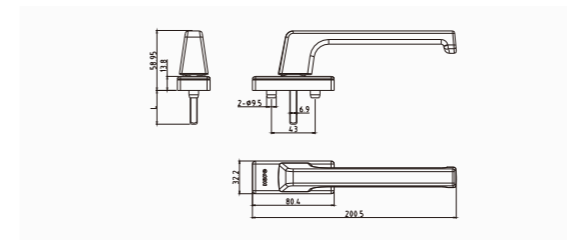

Spindle handle PH183 Stock

Article No:PH183.**.##
 Description:PH183Handle_Spindle length_Color
 Spindle length:Customized
 Surface treatment:Anodized
 Application:Casement doors/sliding doors
 Packing:1pc/bag,2bag/box, 15box/carton

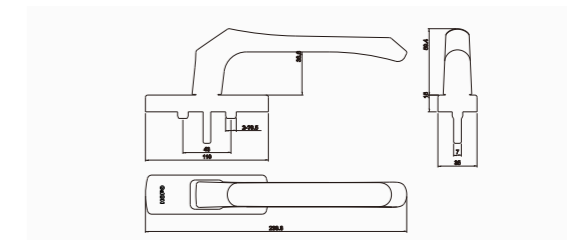



Anti-Theft Gear Case

The gear case can only be operated by handle, preventing toggling locking pins to open the window from outside.

AGC31

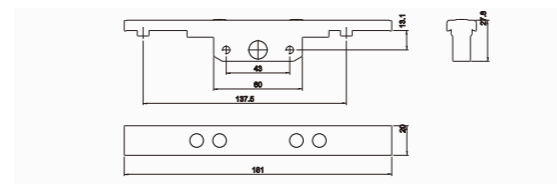
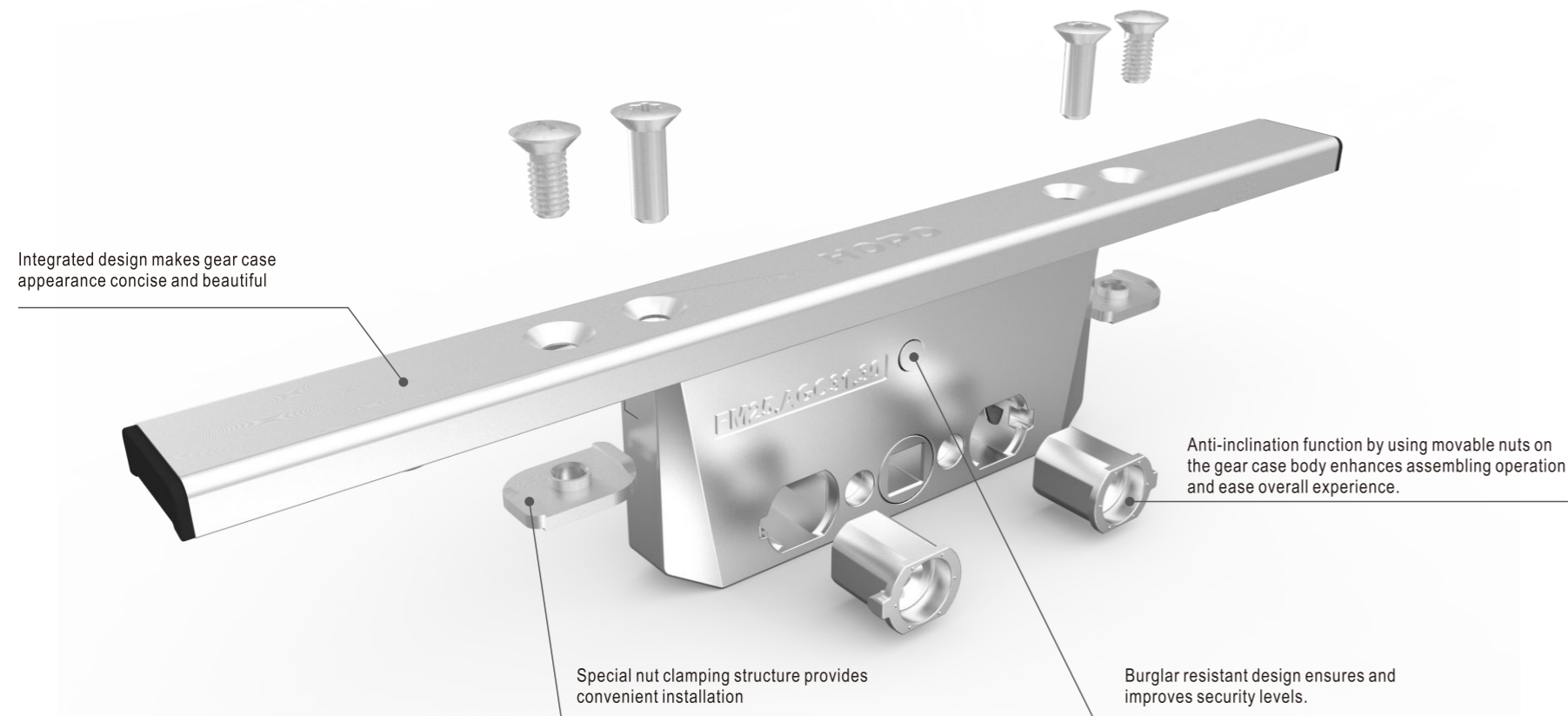

Gear case AGC32.13

Article No:AGC32.13.011

Description:Gear case_13mm Center distance_Anodized silver

Surface treatment:Anodized silver

Application:Casement window

Packing:1pc/bag, 4bag/box, 10box/carton

Screen sash gear case

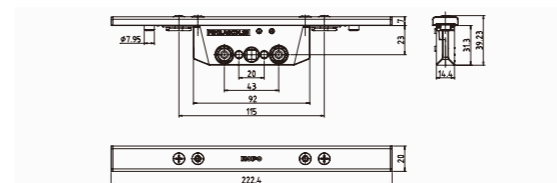

FM18 Gear case AGC31.23

Article No:AGC31.23.1T011

Description:Gear case_23mm Center distance_Anodized silver

Surface treatment:Anodized silver

Application:Inward/outward casement screen sash

Packing:1pc/bag, 4bag/box, 8box/carton

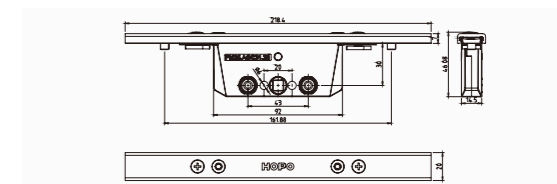

FM25 Gear case AGC31.30

Article No:AGC31.30.1T011

Description:Gear case_30mm Center distance_Anodized silver

Surface treatment:Anodized silver

Application:Inward/outward casement glass sash

Packing:1pc/bag, 4bag/box, 8box/carton

Glass sash gear case

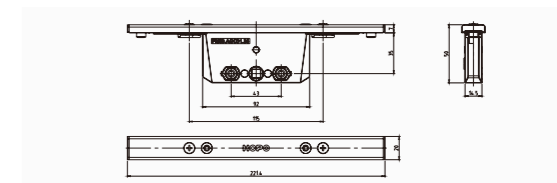

FM30 Gear case AGC31.35

Article No:AGC31.35.1T011

Description:Gear case_35mm Center distance_Anodized silver

Surface treatment:Anodized silver

Application:Outward casement glass sash

Packing:1pc/bag, 4bag/box, 8box/carton

Gear Case

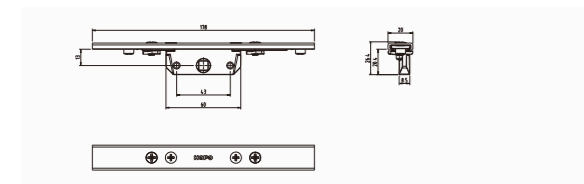

Gear case AGC34.13.011H5

Article No:AGC34.13.011H5

Description: Gear case_13mm Center distance_Anodized silver

Surface treatment:Anodized silver

Application:Inward casement screen sash

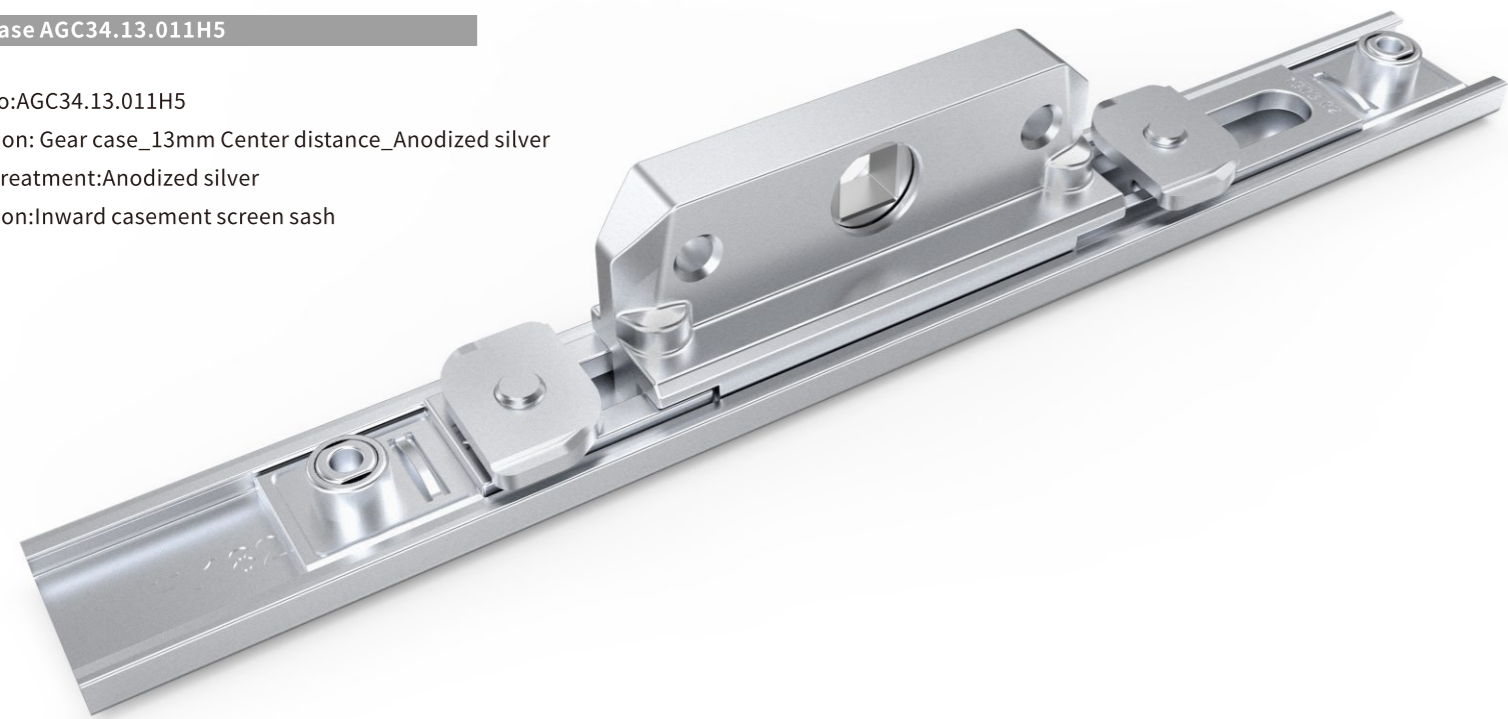

AGC36 Series Gear Case

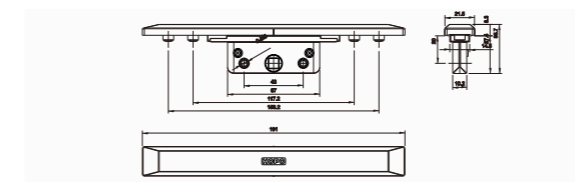

Gear case AGC36.20

Article No:AGC36.20.06H4

Description: Gear case_20mm Center distance_Black

Surface treatment:Power coating

Application:Inward opening window

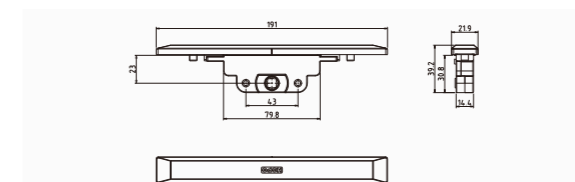

Gear case AGC36.23

Article No:AGC36.23.06H4

Description: Gear case_23mm Center distance_Black

Surface treatment:Power coating

Application:Inward opening window

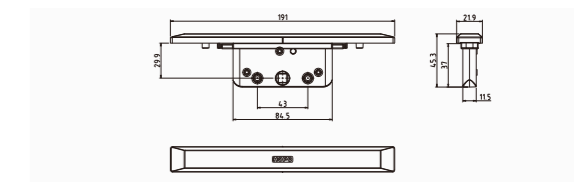

Gear case AGC36.30

Article No:AGC36.30.06H4

Description: Gear case_30mm Center distance_Black

Surface treatment:Power coating

Application:Inward casement/Outward casement glass sash

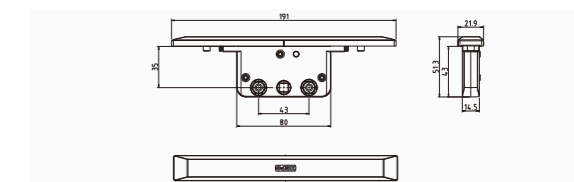

Gear case AGC36.35

Article No:AGC36.35.06H4

Description: Gear case_35mm Center distance_Black

Surface treatment:Power coating

Application:Outward casement glass sash

www.hopo.us

Concealed Handle with Cylinder

Integrated design makes gear case appearance concise and beautiful, no screws in the surface.
Smooth Handle operation improves user experience
Special clamping structure provides convenient installation.
Handle depth complies with dimensions of screen sash.
Can be installed on slim profiles and mosquito sash
Additional cylinder can limit window opening, provides more security for children.



WINDOW AND DOOR





Fork handle AH25

Article No:AH25.00.##H5
 Description:AH25 Fork handle_Fork length_Color
 Fork length:Optional
 Surface treatment:Anodized
 Application:Casement window
 Packing:1pc/bag,4bag/box,15box/carton

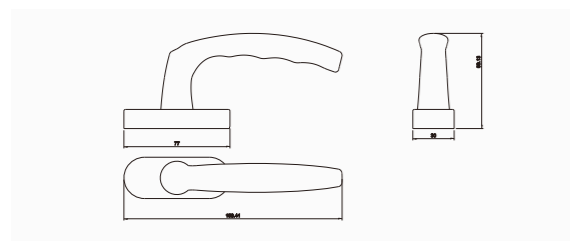

Fork handle AH29

Article No:AH29.00.##H5
 Description:AH29 Fork handle_Fork length_Color
 Fork length:Optional
 Surface treatment:Anodized
 Application:Casement window
 Packing:1pc/bag, 4bag/box, 15box/carton

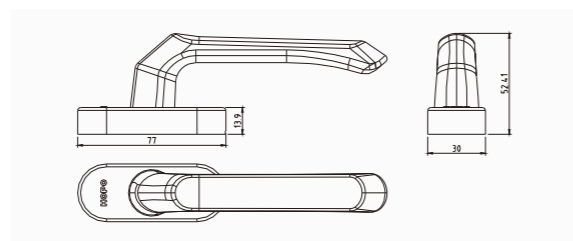

Fork handle AH402 Stock

Article No:AH402.00.##
 Description:AH402 Fork handle_Fork length_Color
 Fork length:Optional
 Surface treatment:Anodized
 Application:Casement window/Sliding door
 Packing:1pc/bag, 2bag/box, 15box/carton

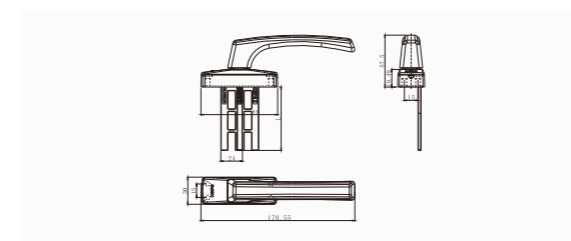

Fork handle AH20

Article No:AH20.00.##L/RH5
 Description:AH20 Fork handle_Fork length_Color_Left/Right
 Fork length:Match spindle (SP07.07.XXC) and fork (AHF35.XXC)
 Surface treatment:Anodized
 Application:Casement window
 Packing:1pc/bag,4bag/box,15box/carton

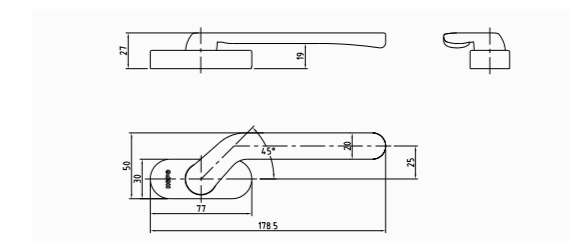



LIFE ART AT FINGERTIPS

The Handle of the Tilt-Turn Window

AH501

WINDOW AND DOOR



AH502

LIFE ART AT FINGERTIPS

The Handle of the Tilt-Turn Window



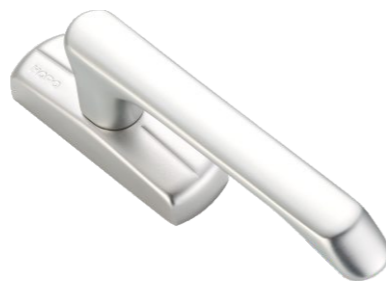
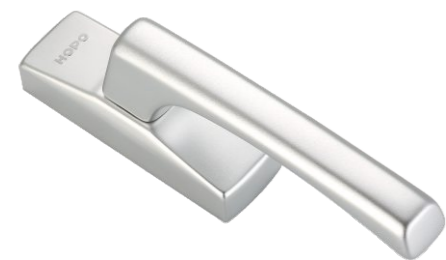

Fork handle AH500

Fork handle AH501

Fork handle AH502

Article No:AH500.22.##
 Description:AH500 Fork handle_Fork length_Color
 Fork length:22mm
 Surface treatment:Anodized/Power coating
 Application:Tilt-Turn Window
 Packing:1pc/bag, 2bag/box, 15box/carton

Article No:AH501.22.##
 Description:AH501 Fork handle_Fork length_Color
 Fork length:22mm
 Surface treatment:Anodized/Power coating
 Application:Tilt-Turn Window
 Packing:1pc/bag, 2bag/box, 15box/carton

Article No:AH502.22.##
 Description:AH502 Fork handle_Fork length_Color
 Fork length:22mm
 Surface treatment:Anodized
 Application:Tilt-Turn Window
 Packing:1pc/bag, 2bag/box, 15box/carton

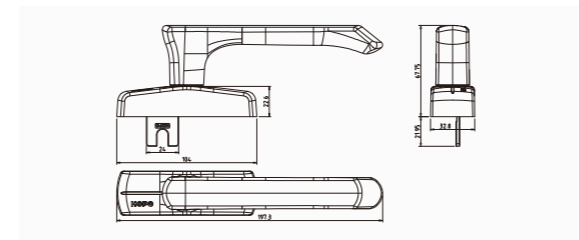
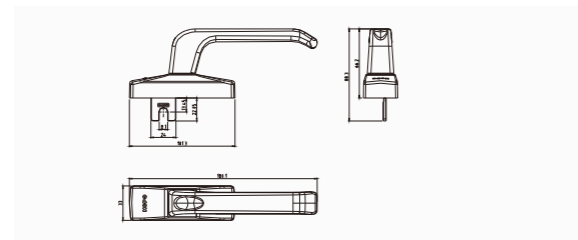
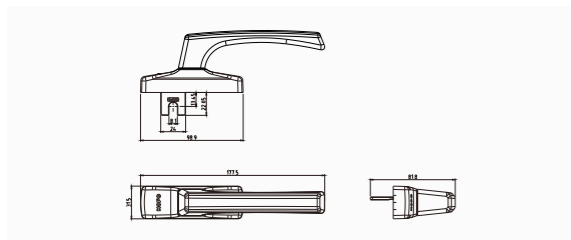



LIFE ART AT FINGERTIPS
Security Handle

AH408



PH175

LIFE ART AT FINGERTIPS
Child Safety Handle

Equipped with in-handle cylinder,
can limit window opening
angle when it is locked.



Spindle handle PH175

Article No:PH175.00.##
 Description: PH175 handle_Spindle length_color
 Spindle length:Without spindle, match SP07 spindle
 Surface treatment:Anodized
 Application:Casement window/screen door
 Packing:1pc/bag,10bag/box,8box/carton

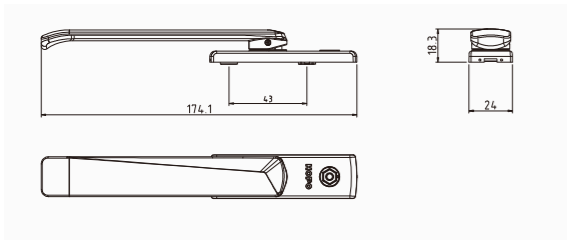

Fork handle AH408

Article No:AH408.00.##
 Description: AH408handle_Without spindle_color
 Fork length:Optional
 Surface treatment:Power coating
 Application:Outward side-hung window
 Packing:1pc/bag,4bag/box,8box/carton

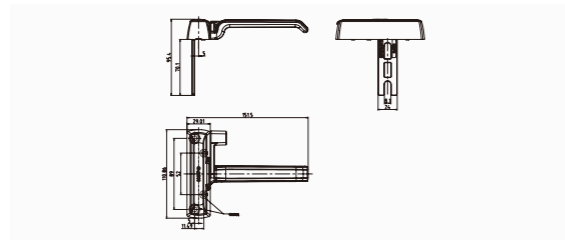

Fork/Spindle handle PH705

Article No:PH705.00.##
 Description: PH705handle_Without spindle_color
 Spindle/Fork length:Match spindle (SP07.12.XXC) and fork (AHF70.27CX)
 Surface treatment:Anodized
 Application:Outward side-hung window
 Packing:1pc/bag,4bag/box,8box/carton

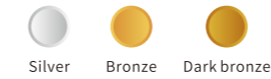
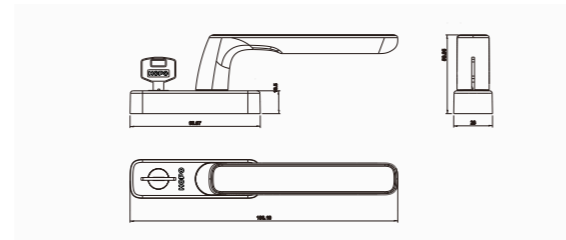

handleMAL500

Article No:MAL500.021.##
 Description: MAL500handle_Fork length_color
 Fork length:21.5mm
 Surface treatment:Anodized
 Application:Outward/Inward opening screen sash window
 Packing:1pc/bag,20bag/box,6box/carton

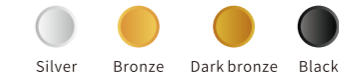
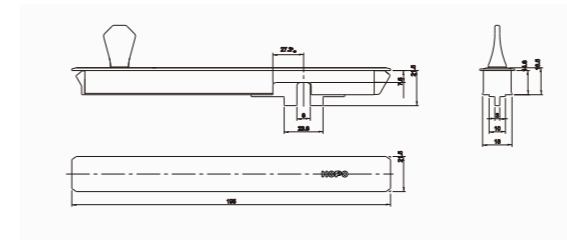

Fork handle AH409

Article No:AH409.22.##
 Description: Concealed fork handle with cylinder_Fork length_color
 Fork length:22mm
 Surface treatment:Power coating
 Application:Outward/Inward opening screen sash window
 Packing:1pc/bag,8bag/box,4box/carton

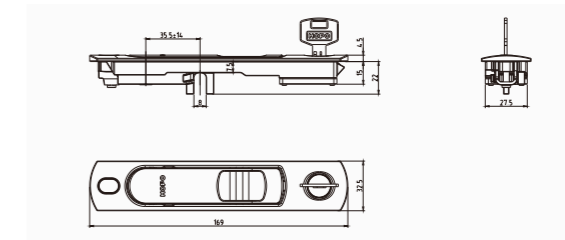

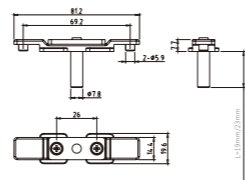

Heavy-duty T-type connector TTC31

Article No:TTC31.**.069X
Description: Heavy-duty T-type connector_ length_Matt black Without logo
Length:19/23mm
Material Description: Zinc alloy, powder coating
Application:Inward/outward casement screen sash
Packing:40PC/box, 8box/carton (30pc/bag, 8box/carton)

Screen Sash T-type Connector

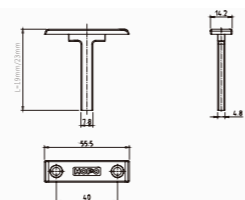

Heavy-duty T-type connector TTC29

Article No:TTC29.**.069
Description: Heavy-duty T-type connector_ length_Matt black
Length:19/23mm
Material Description: Zinc alloy, powder coating
Application:Inward/outward casement screen sash
Packing:40PC/bag, 5box/carton (30pc/bag,5box/carton)

Glass Sash T-type Connector

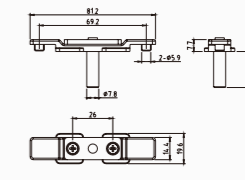

Heavy-duty T-type connector TTC31

Article No:TTC31.**.069X
Description: Heavy-duty T-type connector_ length_Matt black Without logo
Length:26/28/35/45/50/65mm
Material Description: Zinc alloy, powder coating
Application:Inward/outward casement glass sash
Packing:40PC/box, 8box/carton (30pc/bag, 8box/carton)

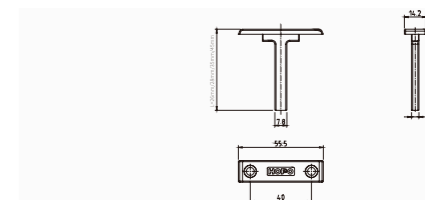

Heavy-duty T-type connector TTC29

Article No:TTC29.**.069
Description: Heavy-duty T-type connector_ length_Matt black
Length:26/28/35/45mm
Material Description:Zinc alloy, powder coating
Application:Inward/outward casement glass sash
Packing:40PC/bag, 5box/carton (30pc/bag, 5box/carton)

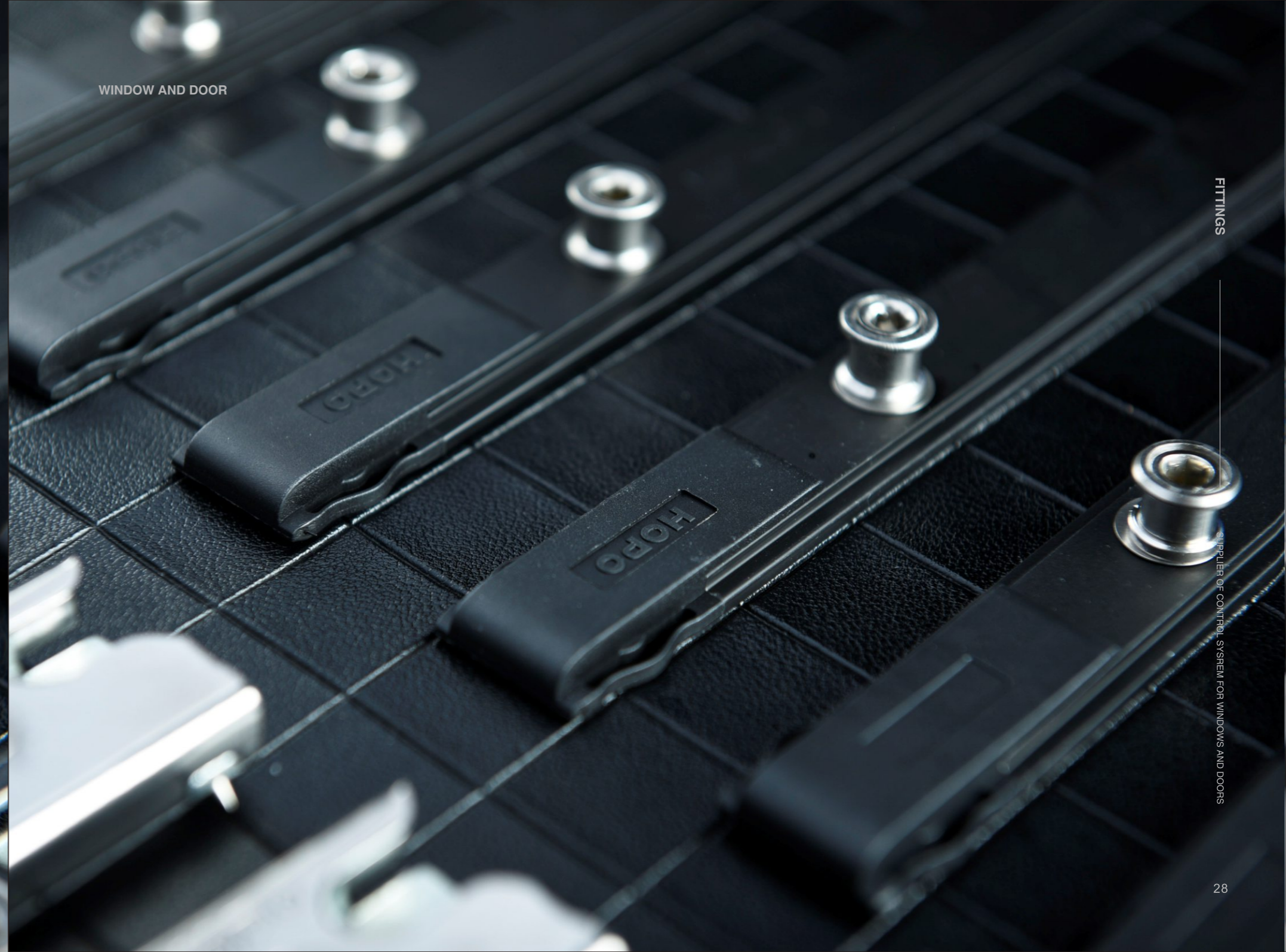

Prying-Resistant and Silence Transmission Rod

Transmission rod equipped with prying-resistant locking pin improves the security level of window and door. Noise block in the transmission rod makes it smooth and silent.

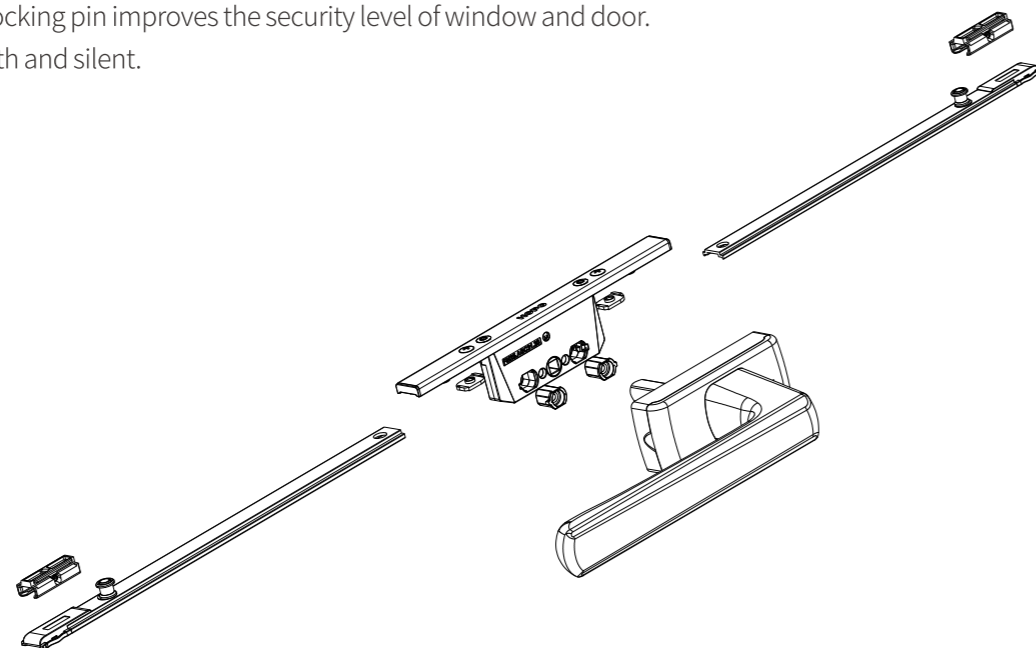

WINDOW AND DOOR

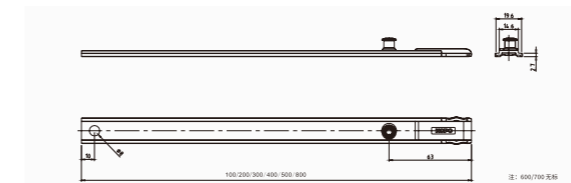

Transmission rod DR21

Article No:DR21.**.066H4
 Description: DR21 Aluminum alloy rod_
 Total length_Black
 Length:100/200/300/400/500/800mm available
 Material Description:Aluminium alloy
 Application:Casement window (Use with gear case)
 Packing:2pc/bag, 25bag/carton

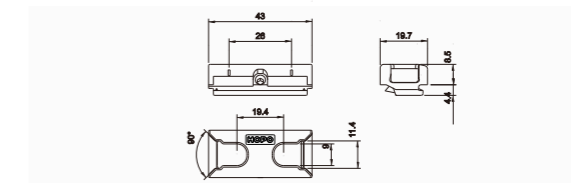

C groove locking plate ALP33

Article No:ALP33.00.021H4
 Description: Security locking plate_
 Regular_Electroplating zinc color HOPO
 Material Description:Electroplating zinc color
 Application:Suitable for C groove casement windows

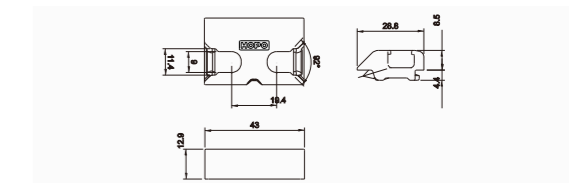

K groove locking plate ALP34

Article No:ALP34.00.021H4
 Description: Security locking plate_
 K groove_Electroplating zinc color HOPO
 Material Description:Electroplating zinc color
 Application:Suitable for K groove casement windows

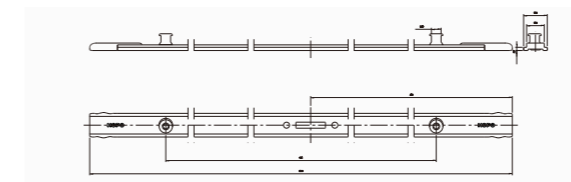

Transmission rod DR20

Article No:DR20.**.##.066H4
 Description: DR20 Aluminum alloy rod_Total length_Black
 Length:800/1000mm available
 Material Description:Aluminium alloy
 Application:Casement window (Use with T-type connector)
 Packing:2pc/bag, 8bag/carton

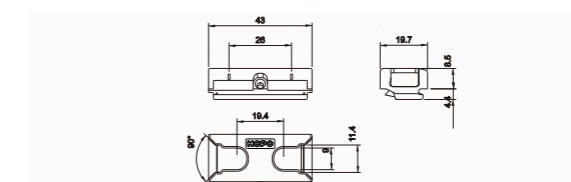

C groove locking plate ALP33

Article No:ALP33.00.021H4
 Description: Security locking plate_
 Regular_Electroplating zinc color HOPO
 Material Description:Electroplating zinc color
 Application:Suitable for C groove casement windows

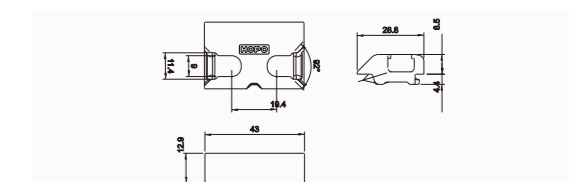

K groove locking plate ALP34

Article No:ALP34.00.021H4
 Description: Security locking plate_
 K groove_Electroplating zinc color HOPO
 Material Description:Electroplating zinc color
 Application:Suitable for K groove casement windows

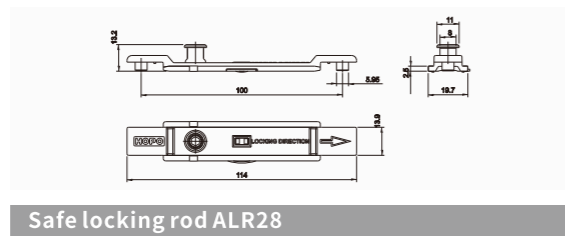

Safe locking rod ALR28

Article No:ALR28.00.021H4
 Description: Locking rod_Normal_Electroplating zinc color HOPO
 Material Description:Electroplating zinc color
 Application:Suitable for standard C groove aluminum profiles

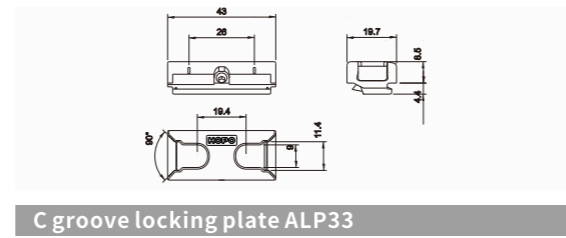

C groove locking plate ALP33

Article No:ALP33.00.021.H4
 Description: Security locking plate_Normal_Electroplating zinc color HOPO
 Material Description:Electroplating zinc color
 Application:Suitable for C groove casement windows

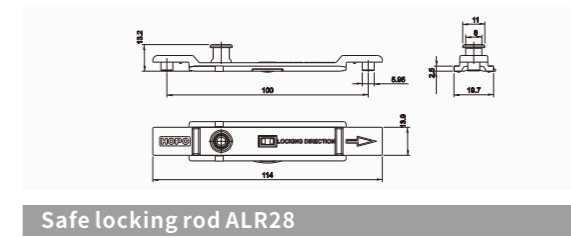

Safe locking rod ALR28

Article No:ALR28.00.021H4
 Description: Locking rod_Normal_Electroplating zinc color HOPO
 Material Description:Electroplating zinc color
 Application:Suitable for standard C groove aluminum profiles

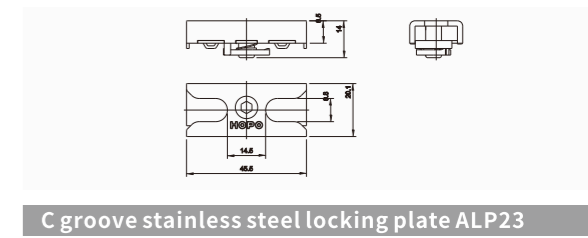

C groove stainless steel locking plate ALP23

Article No:ALP23.00.38H5
 Description: locking plate_Normal_Stainless steel HOPO
 Material Description:Stainless steel
 Application:Suitable for C groove casement windows

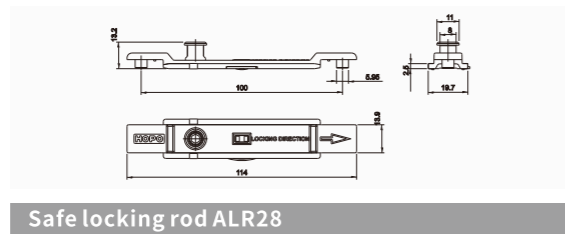

Safe locking rod ALR28

Article No:ALR28.00.021H4
 Description: Locking rod_Normal_Electroplating zinc color HOPO
 Material Description:Electroplating zinc color
 Application:Suitable for standard C groove aluminum profiles

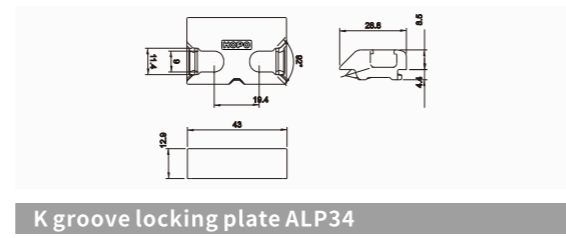

K groove locking plate ALP34

Article No:ALP34.00.021H4
 Description: Security locking plate_K groove_Electroplating zinc color HOPO
 Material Description:Electroplating zinc color
 Application:Suitable for K groove windows

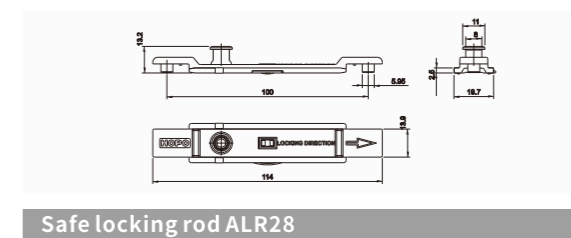

Safe locking rod ALR28

Article No:ALR28.00.021H4
 Description: Locking rod_Normal_Electroplating zinc color HOPO
 Material Description:Electroplating zinc color
 Application:Suitable for standard C groove aluminum profiles

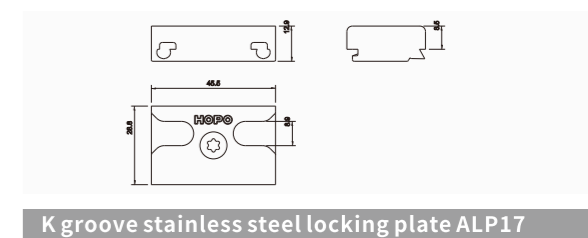

K groove stainless steel locking plate ALP17

Article No:ALP17.30.38H5
 Description: Anti-theft locking plate_K groove_Stainless steel
 Material Description:Stainless steel, polishing
 Application:Suitable for K groove casement doors and windows

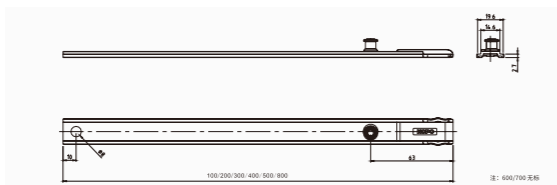

Transmission rod DR21

Article No:DR21.**.066H4
 Description: DR21Aluminum alloy rod_Total length_color
 Length:100/150/200/300/400/500/600/800mm available
 Material Description:Aluminium alloy
 Application:Casement window (Use with gear case)

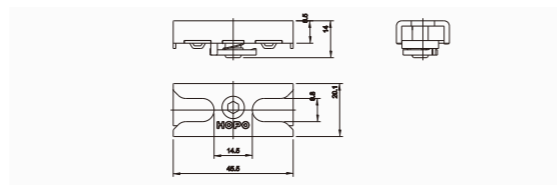

C groove stainless steel locking plate ALP23

Article No:ALP23.00.38H5
 Description: locking plate_Normal_Stainless steel HOPO
 Material Description:Stainless steel
 Application:Suitable for C groove casement windows

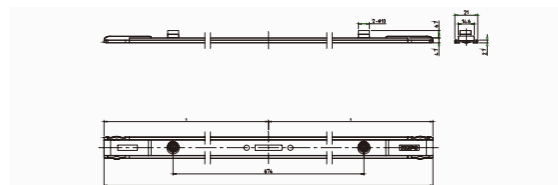

Transmission rod DR20

Article No:DR20.**.066H4
 Description: DR20Aluminum alloy rod_Total length_color
 Length:1000mm
 Material Description:Aluminium alloy
 Application:Casement window (Use with TTC29)

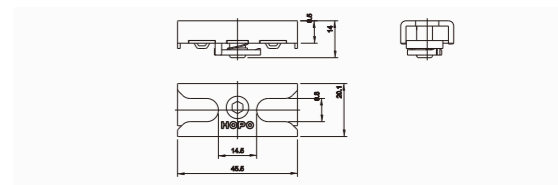

C groove stainless steel locking plate ALP23

Article No:ALP23.00.38H5
 Description: locking plate_Normal_Stainless steel HOPO
 Material Description:Stainless steel
 Application:Suitable for C groove casement windows

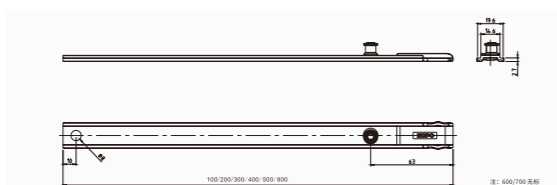

Transmission rod DR21

Article No:DR21.**.066H4
 Description: DR21Aluminum alloy rod_Total length_color
 Length:100/150/200/300/400/500/600/800mm available
 Material Description:Aluminium alloy
 Application:Casement window (Use with gear case)

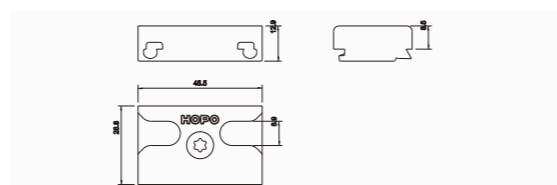

K groove stainless steel locking plate ALP17

Article No:ALP17.30.38H5
 Description: Anti-theft locking plate_
 K groove_Stainless steel
 Material Description:Stainless steel, polishing
 Application:Suitable for K groove casement doors and windows

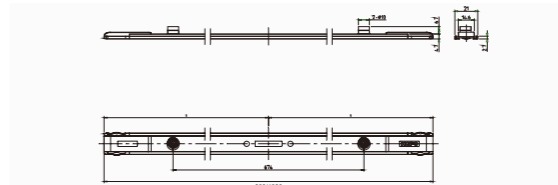

Transmission rod DR20

Article No:DR20.**.066H4
 Description: DR20Aluminum alloy rod_Total length_color
 Length:1000mm
 Material Description:Aluminium alloy
 Application:Casement window (Use with TTC29)

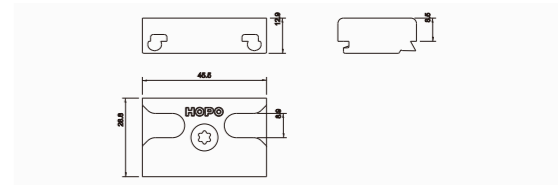

K groove stainless steel locking plate ALP17

Article No:ALP17.30.38H5
 Description: Anti-theft locking plate_
 K groove_Stainless steel
 Material Description:Stainless steel, polishing
 Application:Suitable for K groove casement doors and windows

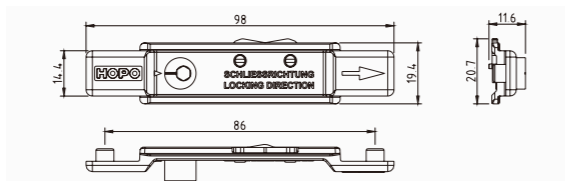

Locking rod ALR10 **Stock**

Article No:ALR10.**.021
 Description: Locking rod_Normal_
 Electroplating zinc color HOPO
 Height:6.5/8/10mm
 Material Description:Electroplating zinc color
 Application:Suitable for standard C groove aluminum profiles

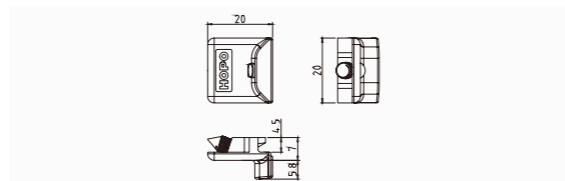

C groove locking plate ALP10 **Stock**

Article No:ALP10.00.021
 Description: C groove locking plate_
 Normal_Electroplating zinc color HOPO
 Material Description:Electroplating zinc color
 Application:Suitable for standard C groove aluminum profiles, Metal fasteners installation, unadjustable

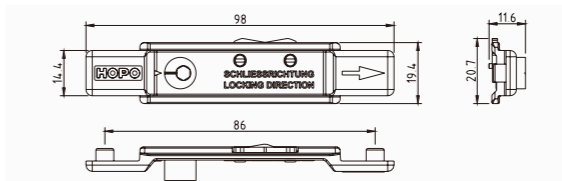

Locking rod ALR10

Article No:ALR10.00.021
 Description: Locking rod_Normal_
 Electroplating zinc color HOPO
 Material Description:Electroplating zinc color
 Application:Suitable for standard C groove aluminum profiles

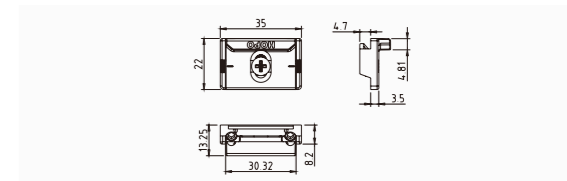

C groove adjustable locking plate AALP10

Article No:AALP10.021
 Description: C groove adjustable locking plate_Electroplating zinc color HOPO
 Material Description:Electroplating zinc color
 Application:C groove profiles of European standard metal fasteners installation adjustable function

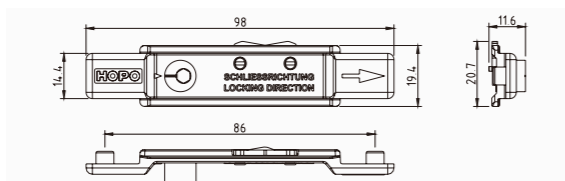

Locking rod ALR10

Article No:ALR10.00.021
 Description: Locking rod_Normal_
 Zinc color HOPO
 Material Description:Electroplating zinc color
 Application:Suitable for standard C groove aluminum profiles

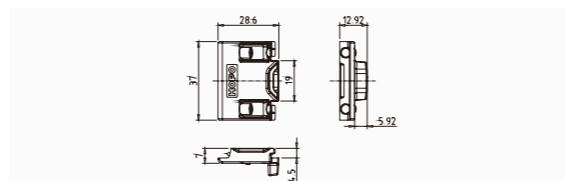

K groove locking plate ALP30

Article No:ALP30.00.021
 Description: K groove locking plate_
 Normal_Electroplating zinc color HOPO
 Material Description:Electroplating zinc color
 Application:Suitable for K groove profiles

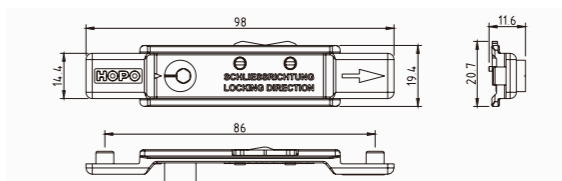

Locking rod ALR10

Article No:ALR10.00.021
 Description: Locking rod_Normal_
 Electroplating zinc color HOPO
 Material Description:Electroplating zinc color
 Application:Suitable for standard C groove aluminum profiles

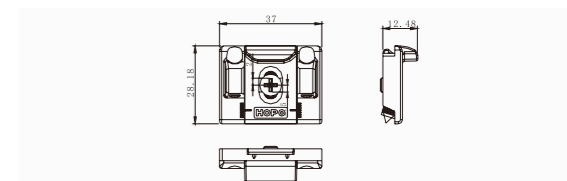

K groove adjustable locking plate AALP20

Article No:AALP20.021
 Description: K groove adjustable locking plate_Electroplating zinc color HOPO
 Material Description:Electroplating zinc color
 Application:K groove profiles of European standard, Metal fasteners installation, Adjustable function





C groove flush sash light duty hinge CATH21.00

Article No:CATH21.00.38

Description: Concealed hinge_C groove_Stainless steel

Material Description:304 Stainless steel

Application:European standard C groove frame sash flush screen/door,regular screen windows/doors

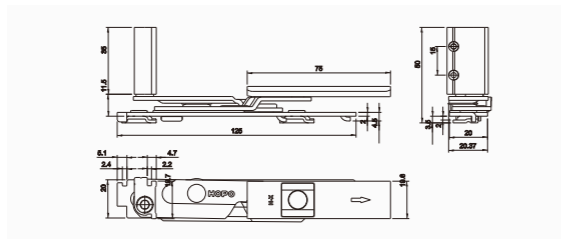

K groove flush sash light duty hinge CATH21.30

Article No:CATH21.30.38

Description: Concealed hinge_K groove_Stainless steel

Material Description:304 Stainless steel

Application:K groove frame sash flush screen/door, regular screen windows/doors

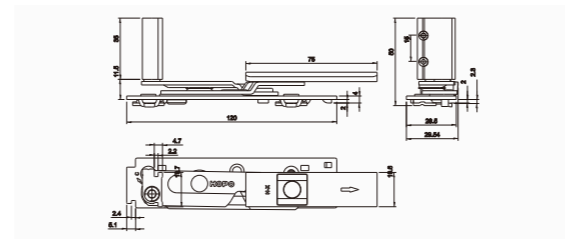

Concealed hinge CATH22

Article No:CATH22.00.38H5

Description: Concealed hinge_C groove_Stainless steel

Material Description:304 Stainless steel

Application:Regular screen windows/doors

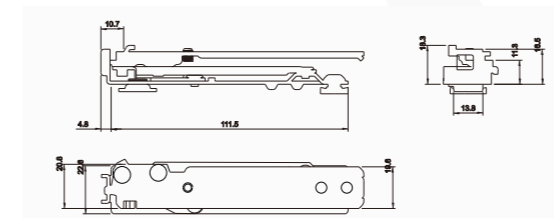

Light Duty Friction Hinge for Flush Profile

A simple “clip” makes structure stable.

The nut and metal clip works together to make installation convenient and fast.

Adjustments are achievable in four directions: Up, down, left, right.

Use of copper sheet in rotating area reduces noise and makes movement smooth.

Usable in flush profile and slim profile.



Heavy Duty Friction Hinge for Flush Profile

Inside-groove integration makes installation easier
 Main connecting part with bearing rivets improves load capacity and life cycle.
 Asymmetric clip and bottom metal supports ensure fast installation and improve security at the same time; also avoid gasket scratches and enhance the sealing effect of window.

C groove friction hinge FH06

Article No: FH06.2316.12C38L/R
 Description: FH06 friction hinge_
 Bottom width 23mm, Stack height 16mm_12 Inch_
 Stainless steel_Left/Right
 Load bearing range: Max load bearing 80kg
 Opening range: Opening Angle 0-85°; Sash width 350-800mm,
 Sash height 400-1700mm
 Application: European standard C groove casement window
 Packing: 1set/bag, 12set/carton

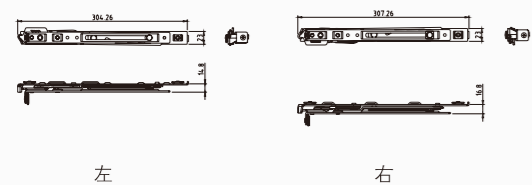

K groove friction hinge FH07

Article No: FH07.3016.12C38L/R
 Description: FH07 friction hinge_Bottom width 30mm, stack height 16mm_X12 Inch
 Load bearing range: Max load bearing 80KG
 Opening range: Opening Angle 0-85°; sash width 350-950mm sash height 400-1900mm
 Application: K groove casement windows
 Packing: 1set/bag, 10set/carton

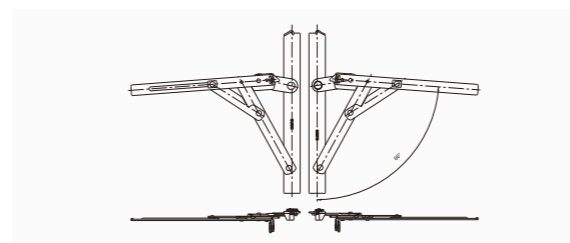

C groove friction hinge FH05

Article No: FH05.2216.14C38
 Description: FH05 friction hinge_Bottom width 22mm stack height 16mm_14Inch_ Stainless steel
 Load bearing range: Max load bearing 50KG
 Opening range: Opening Angle 0-86°, sash width 350-800mm, sash height 400-1700mm
 Application: European standard C groove Casement window
 Packing: 1pair/bag, 16pair/carton

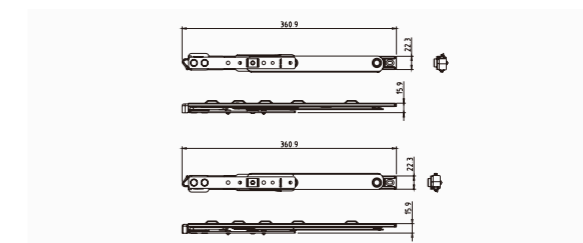

K groove friction hinge FH05

Article No: FH05.2616.14C38H5
 Description: FH05 friction hinge_
 Bottom width 22mm stack height 16mm_14Inch_ Stainless steel
 Load bearing range: Max load bearing 50KG
 Opening range: Opening Angle 0-86°, sash width 450-900mm, sash height 400-1700mm
 Application: K groove casement windows

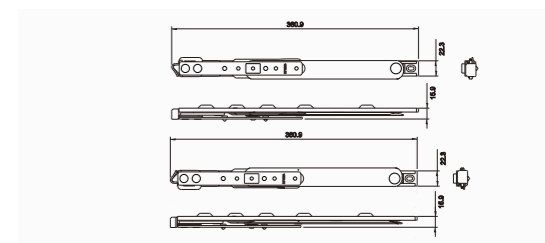

Hinge

Special clamping structure provides convenient installation, screws are no longer required.

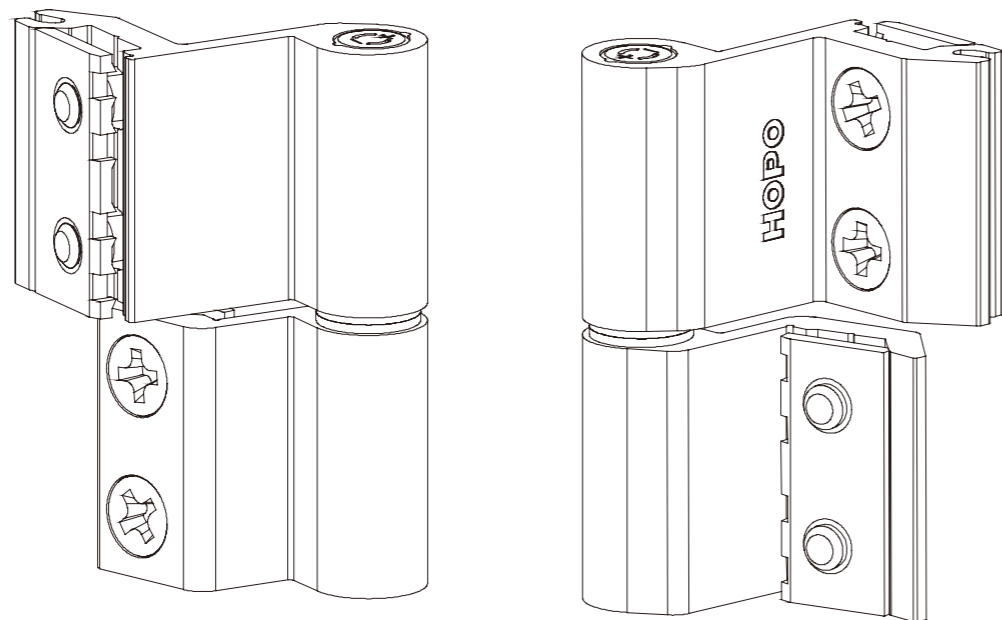

WINDOW AND DOOR



Screen sash hinge AMH54

Article No:AMH54.##
 Description:Screen sash hinge_color
 Surface treatment:Anodized
 Color optional:Silver/Bronze/Dark bronze
 Load bearing range:Double-unit bearing 20KG,
 triple-unit bearing 25KG
 Application:C groove casement windows
 Packing:10 set/box, 100 set/carton

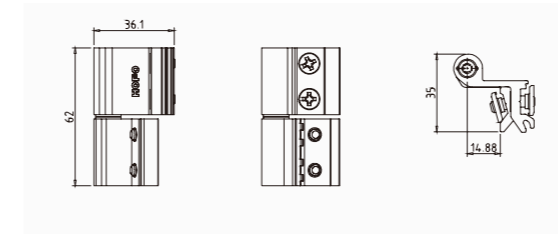

Side-hung hinge AMH51 Stock

Article No:AMH51.##
 Description:Side-hung hinge_color
 Surface treatment:Anodized/Power coating
 Color optional:Silver/Bronze/Dark bronze/Black/White
 Load bearing range:Double-unit bearing 70KG,
 triple-unit bearing 90KG
 Application:C groove casement windows
 Packing:10pc/box, 100pc/carton

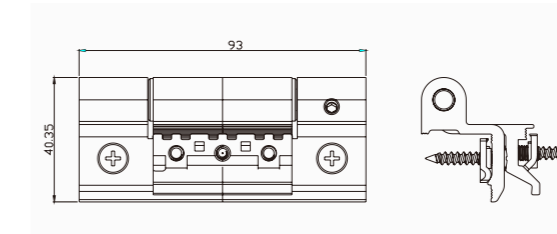

Side-hung hinge AMH53

Article No:AMH53.##
 Description:Side-hung hinge_color
 Surface treatment:Anodized/Power coating
 Color optional:Silver/Bronze/Dark bronze/Black/White
 Load bearing range:Double-unit bearing 70KG,
 triple-unit bearing 90KG
 Application:K groove casement windows
 Packing:10pc/box, 100pc/carton

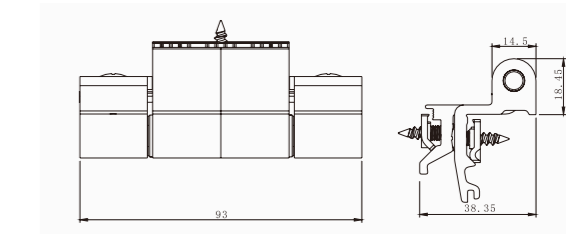



Safety Opening Limiter

Turning the opening limiter to 'Close' will limit window opening angle to prevent accidents if children try to completely open window.

When turned to 'Open', the window can be completely opened for cleaning, ventilation and emergency escape.

Safety Opening Limiter AASA20

Article No:AASA20.00.021

Description:Safety opening limiter_Normal_color

Material Description:Electroplating zinc color

Application:European standard C groove casement window

Packing:1set/bag, 30bag/carton

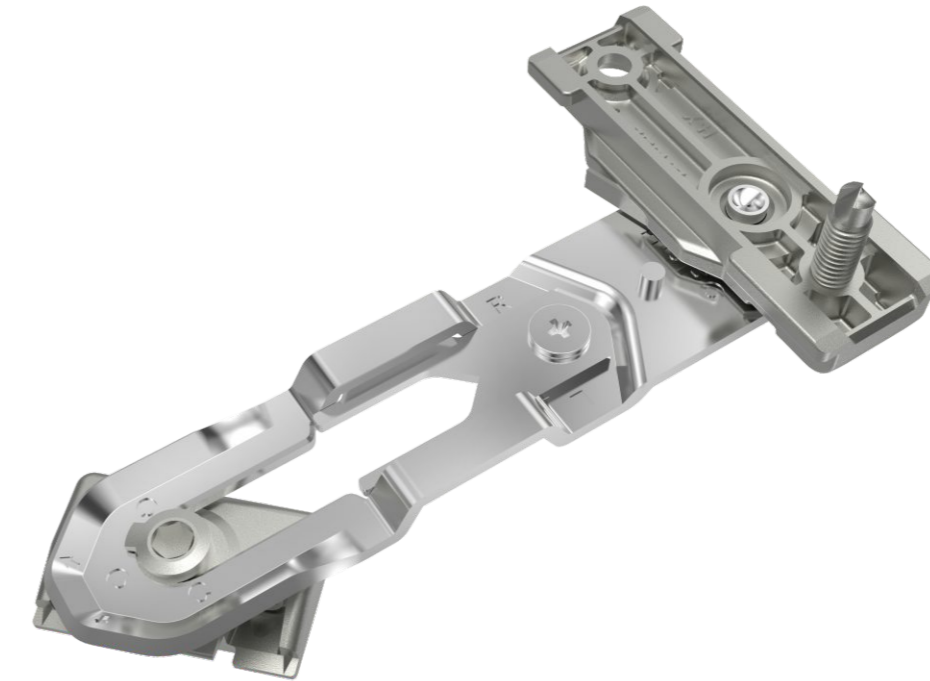
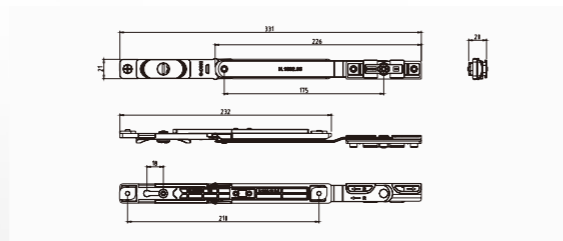

Safety Opening Limiter AASA30.00.38H5

Article No:AASA30.00.38H5

Description:Safety opening limiter_normal_color

Material Description:Stainless steel

Application:European standard C groove casement window

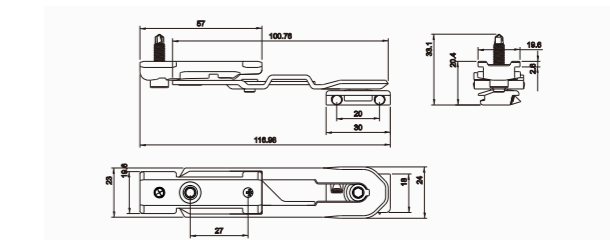



C groove Anti-dropping device ADD20.00 Stock

Article No:ADD20.00.31C011X
Description: Anti-dropping device_Normal_Silver
Length :315mm
Material Description:aluminium alloy
Application:European standard C groove casement window, prevent sashes from falling
Packing:1set/bag 50set/carton

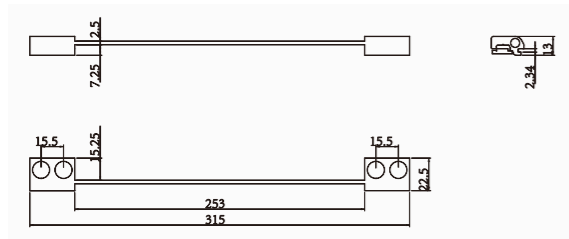

K groove Anti-dropping device ADD20.10

Article No:ADD20.10.011
Description:Anti-dropping device_K groove_Silver
Length :315mm
Material Description:aluminium alloy
Application:K groove casement window, prevent sashes from falling
Packing:20set/box, 200set/carton

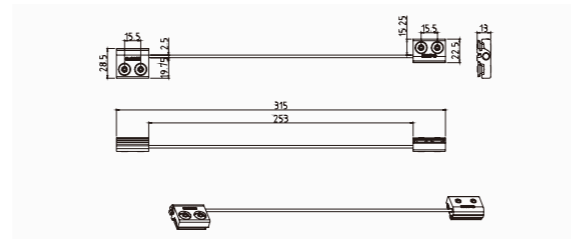

K groove Anti-dropping device ADD20.20

Article No:ADD20.20.011
Description: Anti-dropping device_K groove_Silver
Length :412mm
Material Description:Aluminium alloy
Application:K groove casement window, prevent sashes from falling
Packing:1set/bag, 40set/carton

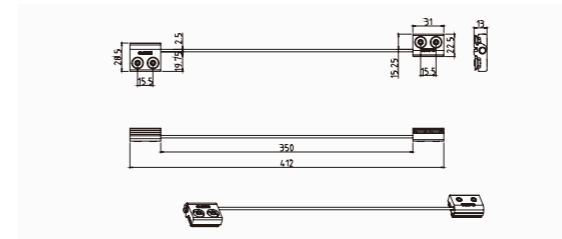

K groove open stay ATR80 Stock

Article No:ATR80.30.12C38
Description: K groove open stay_size_color
Size: 12 Inch
Material Description:Stainless steel, polishing
Application:K groove casement window limit sash opening angle
Packing:1pc/bag, 50pc/carton

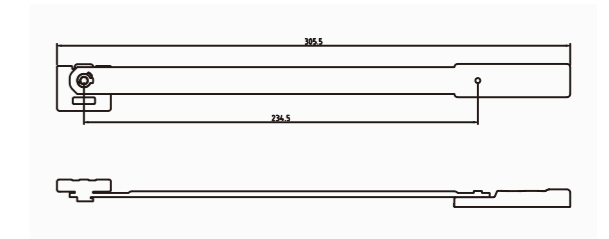



K groove open stay ATR30.12C38 Stock

Article No:ATR30.12C38
 Description: K groove open stay_size_color
 Size:12 Inch
 Material Description:Stainless steel
 Application:K groove casement window, limit sash opening angle
 Packing:1pc/bag, 50bag/carton

Corner transmission device ACT10.00

Article No:ACT10.00.021
 Description: Corner transmission device_Locking pin height 6.5mm_color
 Material Description:Electroplating zinc color
 Application:Casement window
 Packing:20pc/box, 100pc/carton

C groove adjustable middle lock ALP15.00 Stock

Article No:ALP15.00.021
 Description: C groove adjustable middle lock_Normal_color
 Material Description:Electroplating zinc color
 Application:European standard C groove casement doors and windows
 Packing:50set/box, 200set/carton

K groove adjustable middle lock ALP16.00

Article No:ALP16.00.021
 Description: K groove adjustable middle lock_Normal_color
 Material Description:Electroplating zinc color
 Application:K groove casement doors and windows
 Packing:40set/box, 160set/carton

Anti-wind device TBL20.00

Article No:TBL20.00.021
 Description: Anti-wind device_Normal_color
 Material Description:Electroplating zinc color
 Application:European standard C groove casement windows
 Packing:1set/bag, 40bag/box, 5box/carton

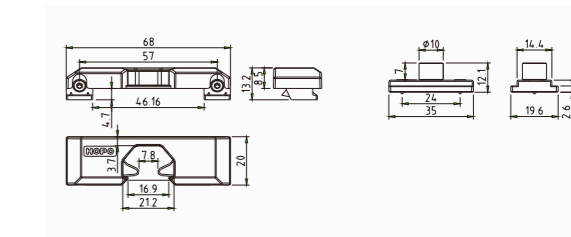
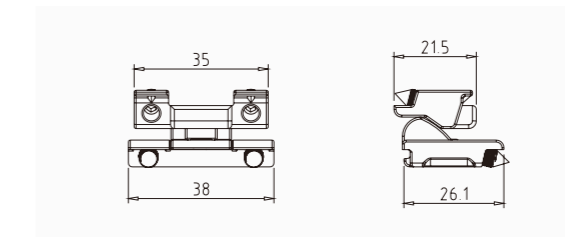
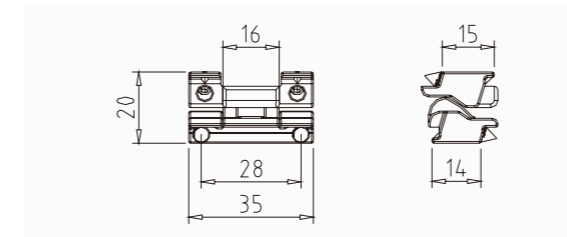
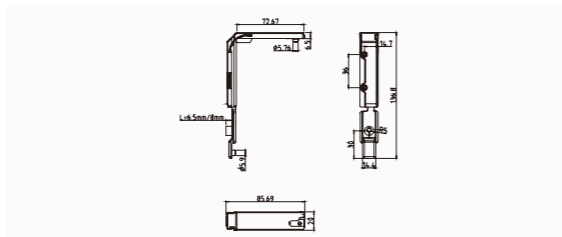
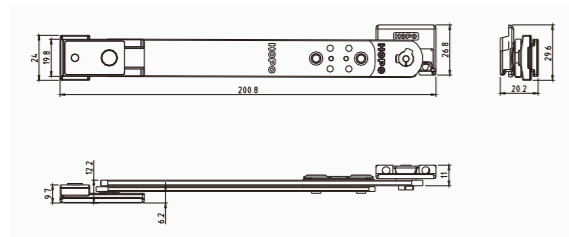



Anti-dropping block AAS10 **Stock**

Article No:AAS10.00.01
 Description:Anti-dropping block_Normal_color
 Material Description:POM
 Application:European standard C groove casement windows
 Packing:100pc/bag, 2bag/box, 5box/carton

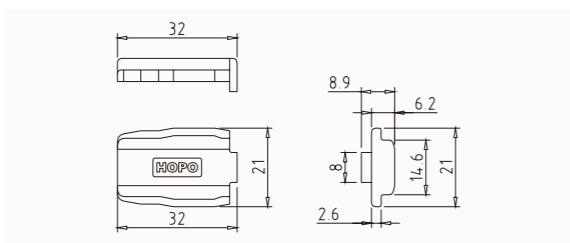

Frame support block AFS10.00 **Stock**

Article No:AFS10.00.01
 Description:Frame support block_Normal_color
 Material Description:POM
 Application:European standard C groove casement windows
 Packing:100pc/bag, 1bag/box, 5box/carton

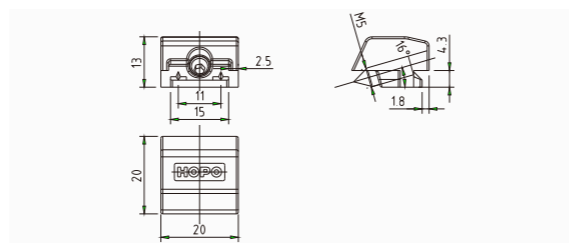

Sash support device ASP20.00

Article No:ASP20.00.021
 Description:ASP20_Normal_color
 Material Description:Electroplating zinc color
 Application:European standard C groove casement window
 Packing:25pc/bag, 2bag/box, 5box/carton

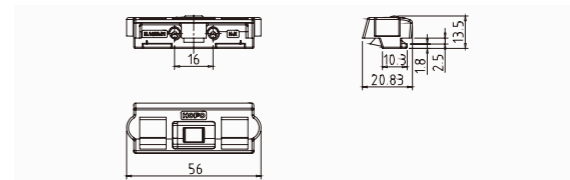

K groove sash support device ASP30.00

Article No:ASP30.00.021
 Description:K groove sash support device_Normal_color
 Material Description:Electroplating zinc color
 Application:K groove casement windows
 Packing:50pc/box, 250pc/carton

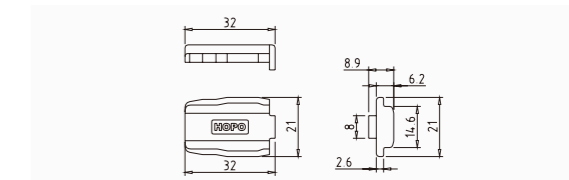
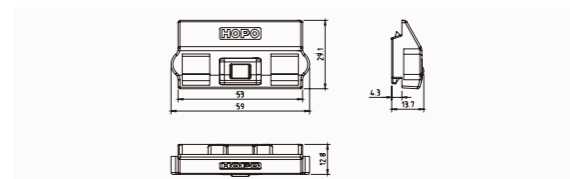

Anti-dropping block AAS10

Article No:AAS10.00.01
 Description:Anti-dropping block_Normal_color
 Material Description:POM
 Application:European standard C groove casement window
 Packing:100pc/bag, 2bag/box, 5box/carton

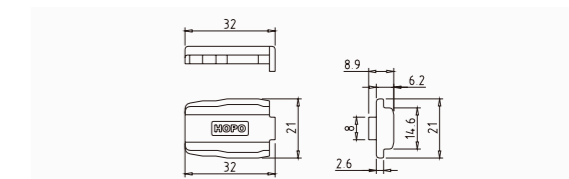

Anti-dropping block AAS10

Article No:AAS10.00.01
 Description:European standard C groove casement window_Normal_color
 Material Description:POM
 Application:K groove casement windows
 Packing:100pc/bag, 2bag/box, 5box/carton

Support part/ Anti-sink accessory



ALPD50

Adjustable locking plate of the door(Right)



22#Mortise lock(left) SDL 51

WINDOW AND DOOR



Double-side door handle sets HSD633



Cylinder



Side-Hung Door & Active Sash

Side free handle can rotate 360°, no need to recognize left or right side.
 Universal profile helps to reduce stock.
 Equipped with mortise lock and multi-point lock that can meet different security requirements.
 The heavy duty concealed hinge hides hardware in front of window, improves concise and beautiful appearance.

WINDOW AND DOOR



Double-side door handle sets HSD633 Stock

Article No:HSD633.XXXX
 Description: 633 Handle set_color
 Installation hole:91.5mm、 118.5mm
 Surface treatment:Anodized/Power coating
 Application:Side-hung door,folding doors
 Packing:1set/box, 8box/carton

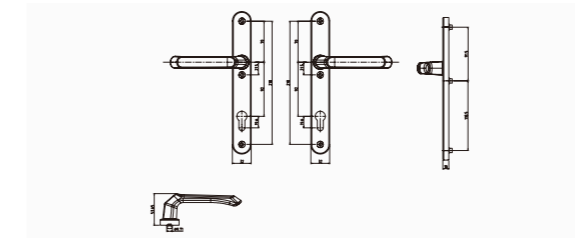

Double-side door handle sets HSD636 Stock

Article No:HSD636.XXXX
 Description: 636 Handle set_color
 Installation hole:91.5mm、 118.5mm
 Surface treatment:Anodized
 Application:Side-hung door
 Packing:2set/box, 6box/carton

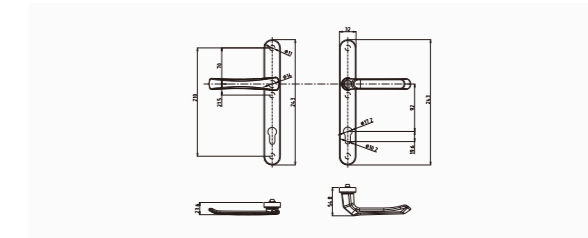

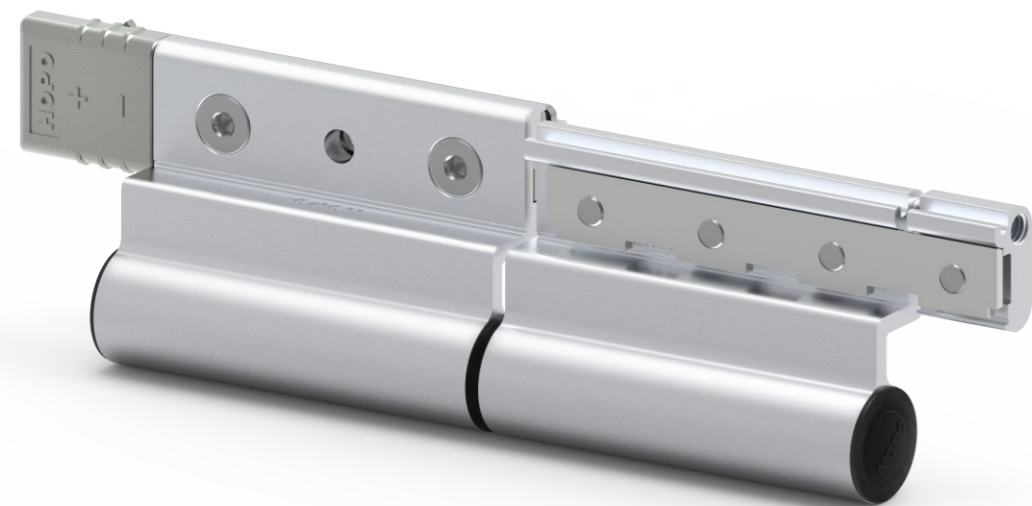

Column hinge ABH53

Article No:ABH53.00.##
 Description: Column hinge_Normal_color
 Surface treatment:Anodized/Power coating
 Color:Silver/Bronze/Dark bronze
 Load bearing range:Double-unit bearing 120KG,
 triple-unit bearing 150KG
 Application:European standard C groove
 casement doors

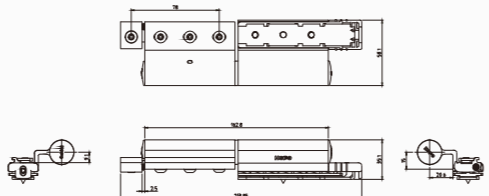

WINDOW AND DOOR



Column hinge ABH51 Stock

Article No:ABH51.00.##
 Description: Column hinge_Normal_color
 Surface treatment:Anodized/Power coating
 Color:Silver/Bronze/Dark bronze/Black/White
 Load bearing range:Double-unit bearing 120KG,
 triple-unit bearing 150KG
 Application:European standard C groove
 casement doors

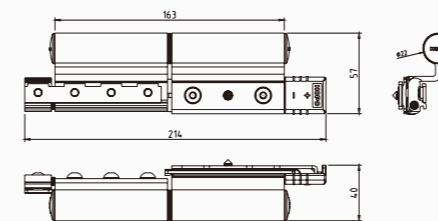

Column hinge ABH52

Article No:ABH52.00.##
 Description: Column hinge_Normal_color
 Surface treatment:Anodized/Power coating
 Color:Silver/Bronze/Dark bronze/Black/White
 Load bearing range:Double-unit bearing 120KG,
 triple-unit bearing 150KG
 Application:K groove casement doors

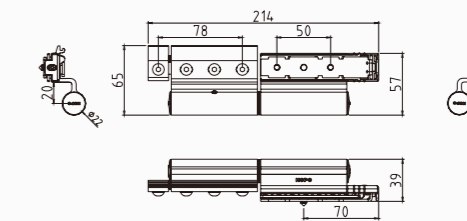

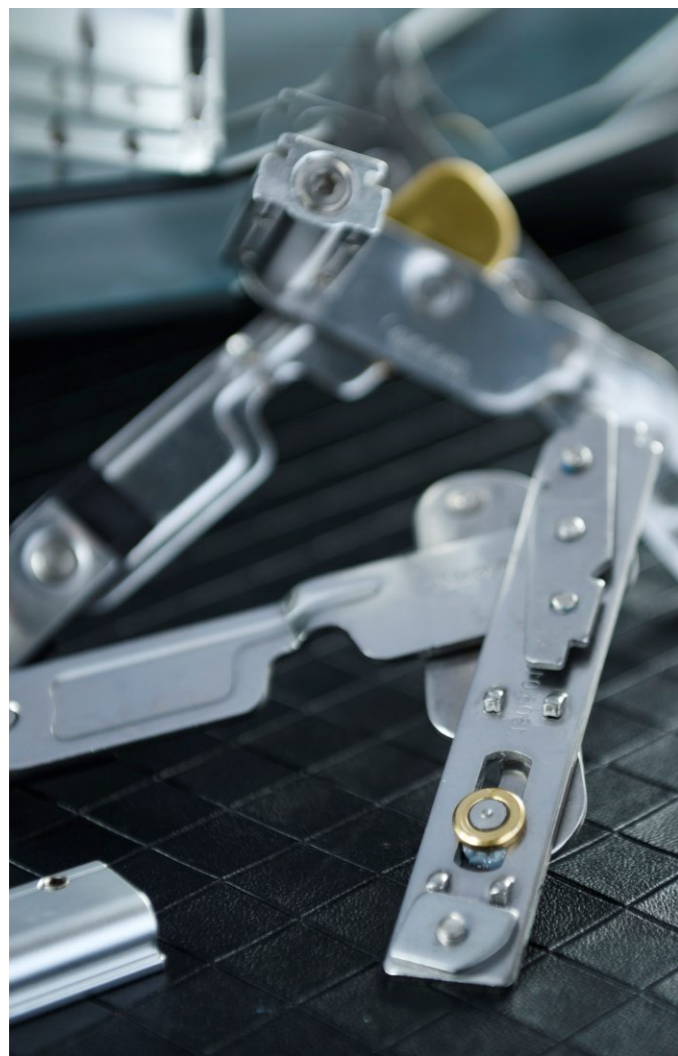

Concealed hinge **CATH 50.10**

Article No:CATH50.10.##L/R
 Description: Concealed hinge_Glass sash_Color_Right/left
 Material:Stainless Steel
 Application:European standard C groove casement door/window
 Load bearing range:MAX 100kg

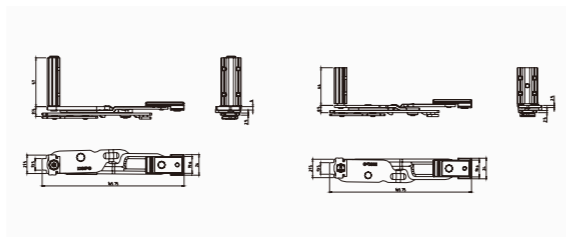

WINDOW AND DOOR



Door locking plate ALPD50.05 Stock R/L

Article No:ALPD50.05.##L/R
 Description: Adjustable locking plate_Flat angle, aluminium_Color_left/right
 Material:Steel
 Application:Casement door
 Packing:30pc/box,150pc/carton

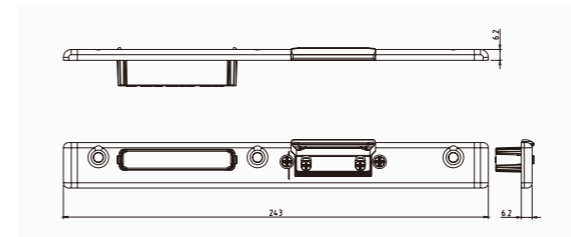

Door locking plate ALPD50.07

Article No:ALPD50.07.38
 Description: Adjustable locking plate_No distinction between left and right_Color
 Material:Stainless Steel
 Application:European standard C groove casement/folding door
 Packing:14pc/box,70pc/carton

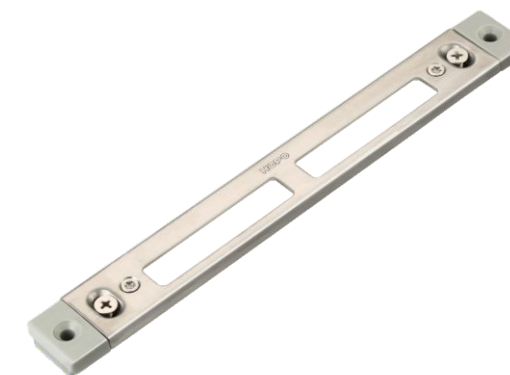
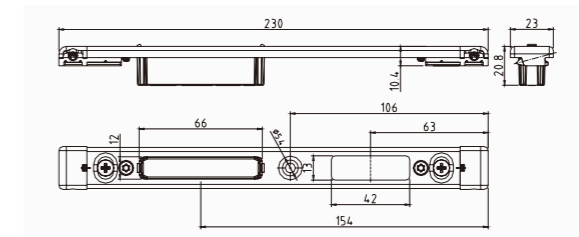

Door locking plate ALPD50.08

Article No:ALPD50.08.38
 Description: Adjustable locking plate_No distinction between left and right_Color
 Material:Stainless Steel
 Application:K groove casement door
 Packing:20pc/box,100pc/carton

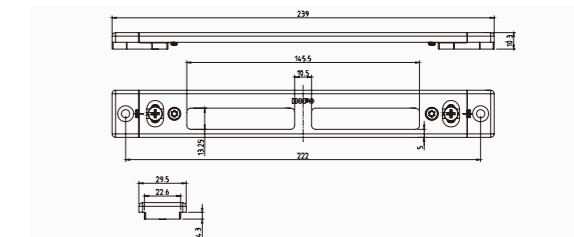



Side-Hung Door & Passive Sash

Equipped with self-lock gear case or concealed gear case
The handle is used to control shoot bolt that opens and closes door, make operation easier.

WINDOW AND DOOR



Double-side door handle sets HSD643 **Stock**

Article No:HSD643.XXXX
Description: Double-side door handle sets_Color
Installation hole:91.5mm、118.5mm
Surface treatment:Anodized
Application:Casement door
Packing:1set/box,8box/carton

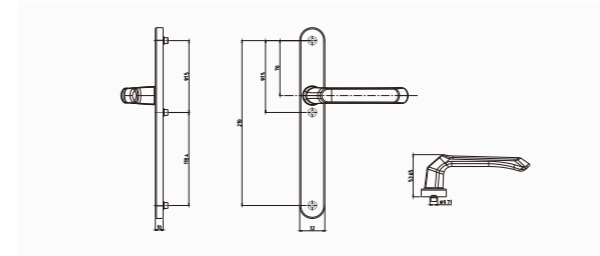

Double-side door handle sets HSD646

Article No:HSD646.XXXX
Description: Double-side door handle sets_Color
Installation hole:91.5mm、118.5mm
Surface treatment:Anodized
Application:Casement door
Packing:2set/box,6box/carton

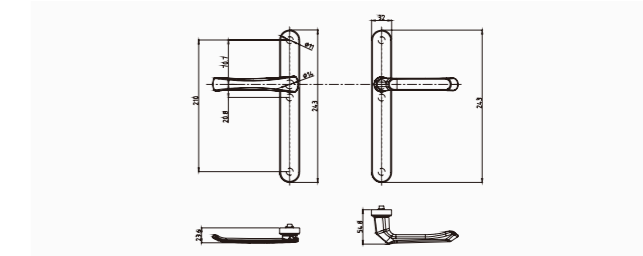



Gear case AGC40.32 Stock

Article No:AGC40.32.021
 Description:Gear case _32 mm center distance_Color
 Material:Color Zinc
 Application:Used for standard C groove aluminum profile
 Packing:1pc/bag,5bag/box,10box/carton

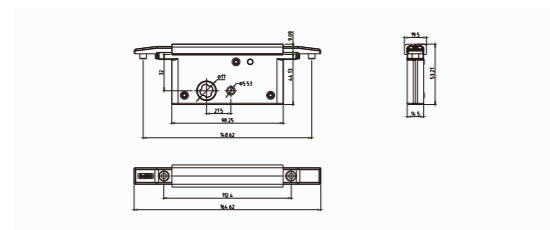

Gear case CGC20 Stock

Article No:CGC20.00.012
 Description:Passive sash gear case _Normal_Color
 Material:Color Zinc
 Application:Used for standard C groove aluminum profile
 Packing:1pc/bag,9bag/box,5box/carton

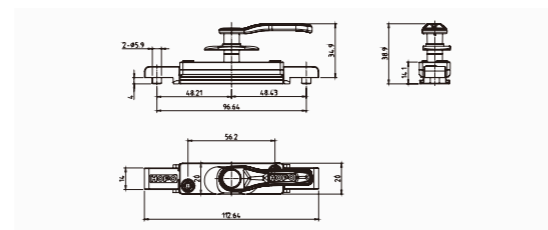

WINDOW AND DOOR

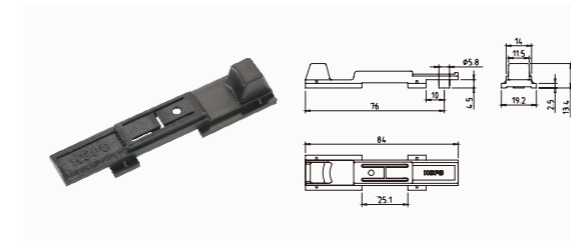

C groove shoot bolt driver ASBH20.00

Article No:ASBH20.00.06
 Description:Shoot bolt driver_Groove_ Black
 Material:POM
 Application:15/20 groove casement door/window,
 passive sash pull driver
 Packing :30pc/box, 150pc/carton (40pc/box, 200pc/carton)

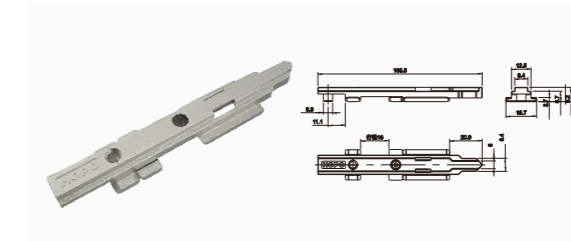

C groove shoot bolt ASB20 Stock

Article No:ASB20.20.021H4
 Description:C groove shoot bolt _Groove_ Black
 Material:Color Zinc
 Application:European standard C groove casement
 door/window
 Packing :50pc/box, 250pc/carton

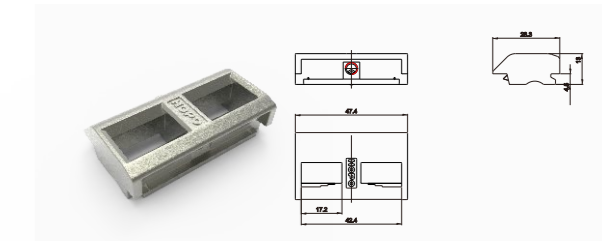

K groove adjustable locking plate ASLP20.05

Article No:ASB20.05.021
 Description:K groove locking plate _Color zinc
 Material:Color Zinc
 Application:K groove casement door/window

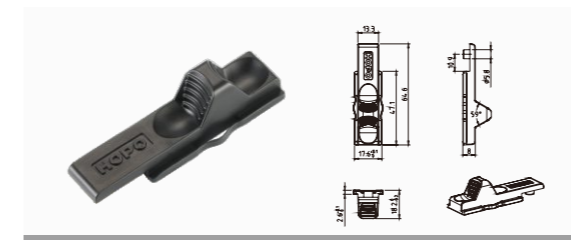

C groove shoot bolt driver ASBH20.10

Article No:ASBH20.10.06
 Description:Shoot bolt driver_Groove_ Black
 Material:POM
 Application:14/18 groove casement door/window,
 passive sash pull driver
 Packing :30pc/box, 150pc/carton (40pc/box, 200pc/carton)

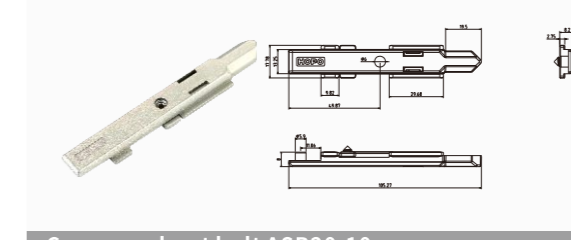

C groove shoot bolt ASB20.10

Article No:ASB20.10.021
 Description:C groove shoot bolt _Groove_ Black
 Material:Color Zinc
 Application:European standard C groove casement
 door/window
 Groove size:14-18mm

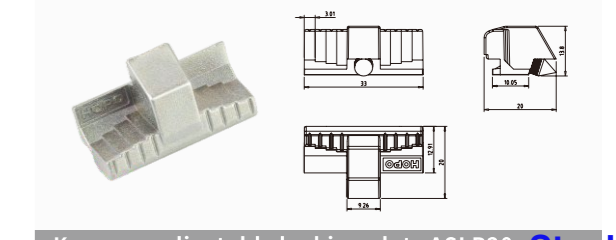

K groove adjustable locking plate ASLP20 Stock

Article No:ASB20.00.021
 Description:Shoot bolt locking plate _Normal_
 Color zinc
 Material:Color Zinc
 Application:14/18 groove casement door/window

LIFE ART
AT FINGERTIPS

Push Button Release MA Lock

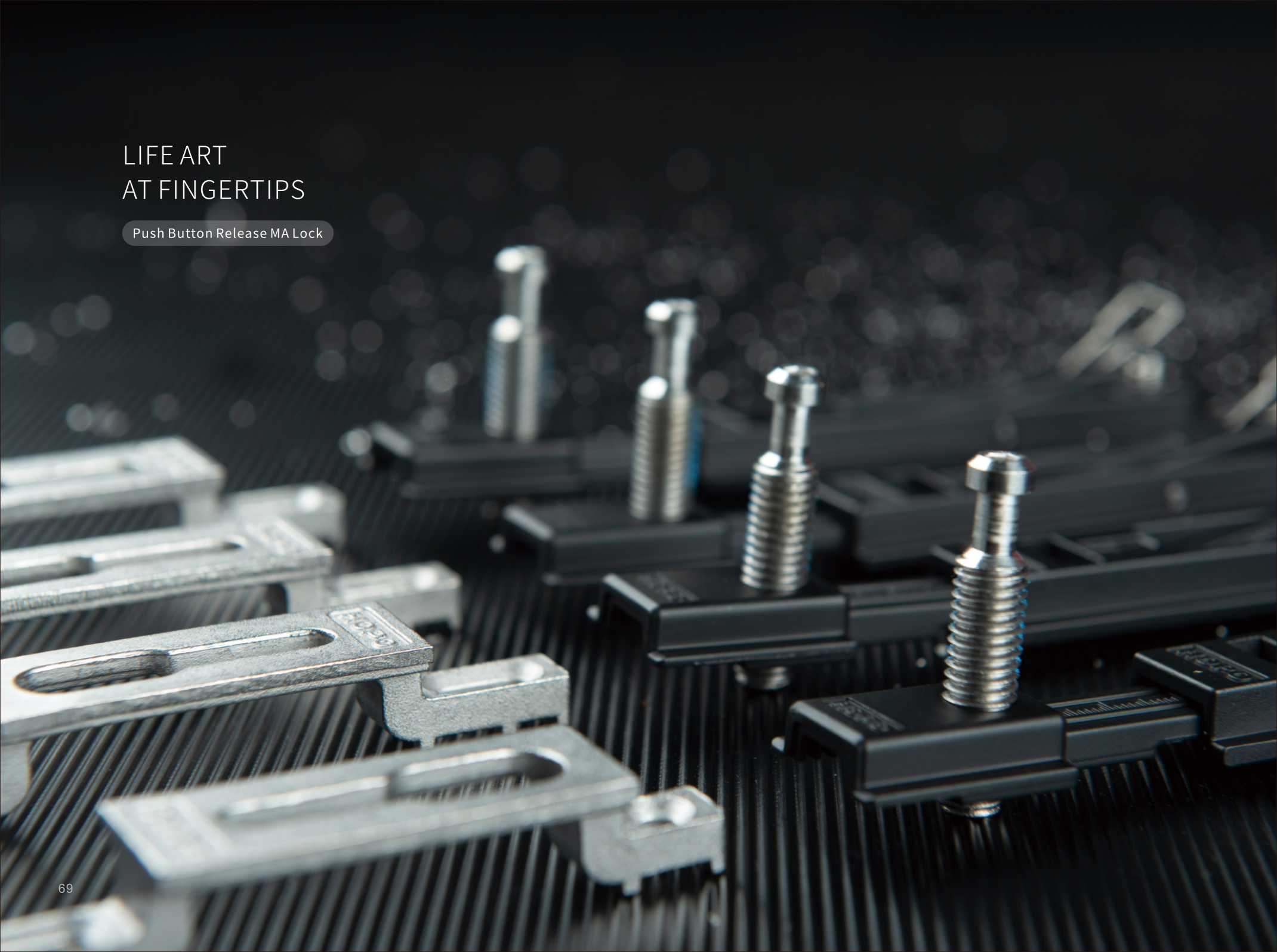

WINDOW AND DOOR

Security handle with cylinder for mosquito sash

MAL500





MA Lock with Cylinder + Automatic MA Lock

A special structure design connects together fork and transfer parts.

The spring-back device allows easier and faster installation.

The child lock design can limit window opening and provide a safer environment at home.

Unique anti-wrong operation T-type connector locking pin and connector unify parts into 1 piece.

Anti-wrong operation T-type connector equipped with 'Child-lock' represents a new automatic MA lock. Can prevent locking rod from breaking and locking plate from malfunctioning.

WINDOW AND DOOR



MA lock MAL425

Article No: MAL425.21.##

Description: 425 MA lock_Fork length 21mm_Color

Surface treatment: Anodized

Application: Sliding door

Packing: 1pc/bag, 20bag/box, 6box/carton

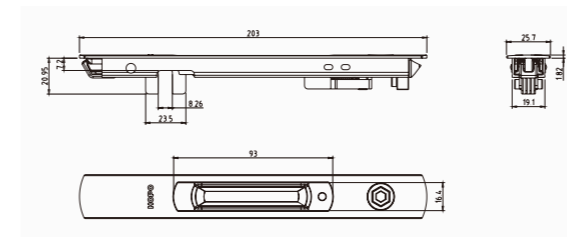

Anti-wrong operation T-type connector LPES43.07

Article No: LPES43.07.50C069

Description: Locking pin set_Diameter 7mm_Height 50mm,color

Material: Zinc alloy

Application: Sliding door/window

Packing: 20set/box, 160set/carton

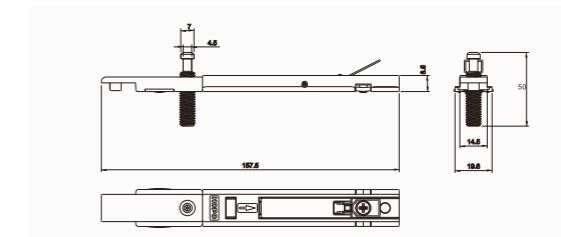

Sliding locking plate SLP47.03

Article No: SLP47.03.069

Description: Heavy duty sliding plate_Normal, wholly concealed_ Black

Material: Zinc alloy

Application: Sliding door/window

Packing: 40pc/box, 320pc/carton

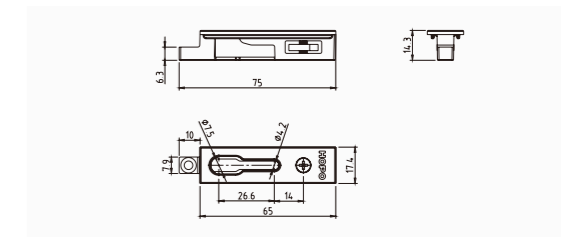



MA lock MAL432.12

Article No: MAL432.12.##
 Description: 432 MA lock_Center distance 12_Color
 Surface treatment: Anodized/Power coating
 Application: Sliding door/window
 Packing: 20pc/box, 120pc/carton

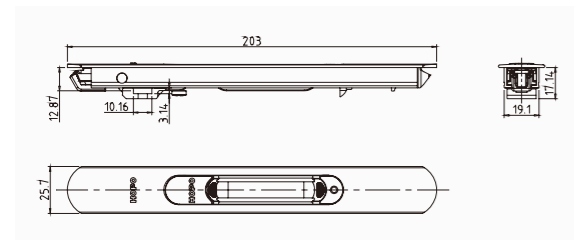

MA lock MAL432.17

Article No: MAL432.17.##
 Description: 432 MA lock_Center distance 17_Color
 Surface treatment: Anodized/Power coating
 Application: Sliding door/window
 Packing: 20pc/box, 120pc/carton

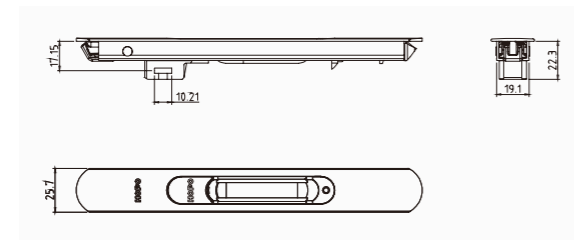

MA lock MAL428.12.011

Article No: MAL428.12.##
 Description: 428 MA lock_Center distance 12.5mm_Color
 Surface treatment: Anodized
 Application: Sliding door/window
 Packing: 20pc/bag, 20bag/box, 6box/carton

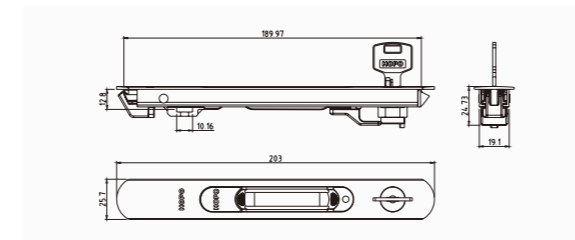

WINDOW AND DOOR



MAL40.06.01C38X (Short, Curved)



MAL41.06.01C38X (Long, Curved)



MAL40.06.02C38X (Short, Straight)



MAL41.06.02C38X (Long, Straight)



① MALP40.01



② MALP40.02



③ SLP41.00.38

Light-Duty MA Lock



MA lock MAL422.** **Stock**

Article No: MAL422.**.##
 Description: 422 MA lock_Without cylinder_Fork_Color
 Fork length: 21/25/30mm
 Surface treatment: Anodized/Power coating
 Application: Sliding door/window
 Packing: 20pc/box, 120pc/carton

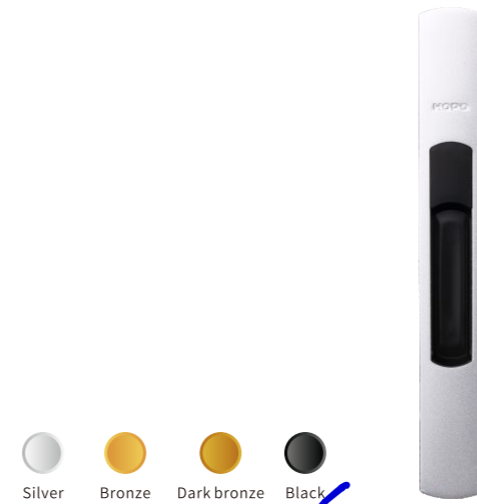
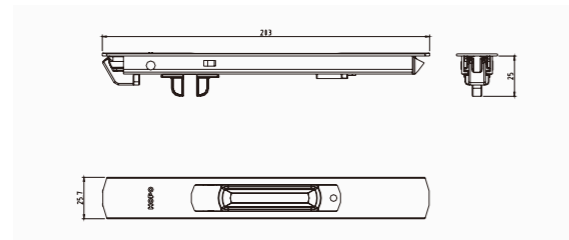

Pull driver BH422.10 **Stock**

Article No: BH422.**.##
 Description: 422 Pull driver_Without cylinder_Color
 Surface treatment: Anodized
 Application: Sliding door, with cylinder
 Packing: 1pc/bag, 20bag/box, 6box/carton

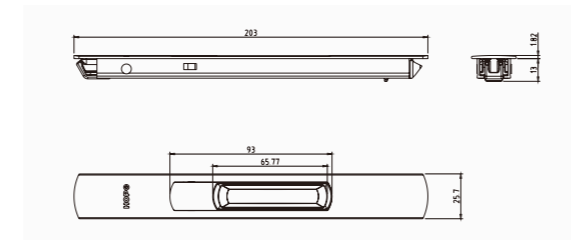

WINDOW AND DOOR



MA lock MAL427.21.011

Article No: MAL427.21.##
 Description: 427 MA lock_Fork 21mm_Color
 Fork length: 21mm
 Surface treatment: Anodized
 Application: Sliding door/window
 Packing: 1pc/bag, 20bag/box, 6box/carton

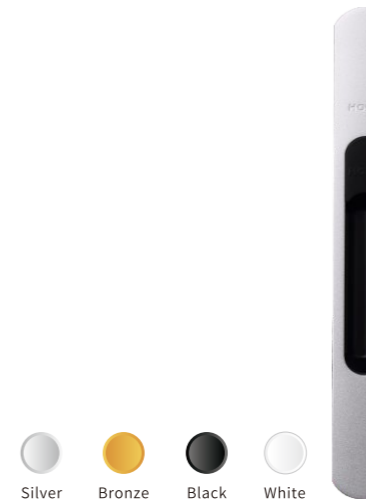
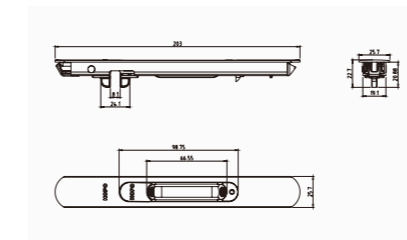

Pull driver BH60.37

Article No: BH60.37.##
 Description: Pull driver_Color
 Surface treatment: Anodized/Power coating
 Application: Sliding door/window, used with MA lock
 Packing: 1pc/bag, 20bag/box, 6box/carton

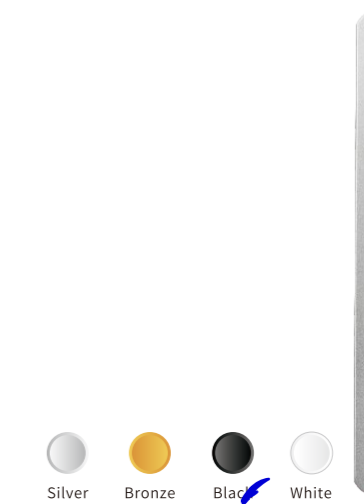
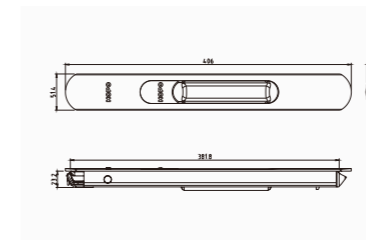

MA lock MAL436.** **Stock**

Article No: MAL436.**.##
 Description: 426 MA lock_Fork length_Color
 Fork length: 21/25/30mm
 Surface treatment: Anodized/Power coating
 Application: Sliding door/window
 Packing: 1pc/bag, 20bag/box, 6box/carton

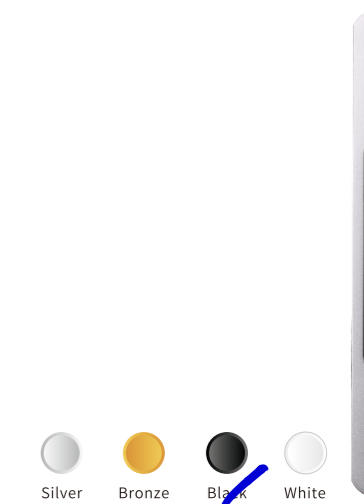
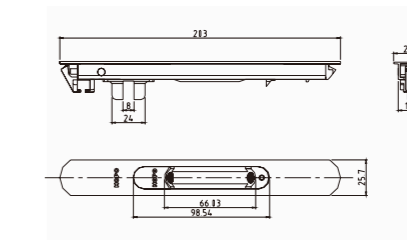

Pull driver BH60.37 **Stock**

Article No: BH60.37.##
 Description: Pull driver_Color
 Surface treatment: Anodized/Power coating
 Application: Sliding door/window, used with MA lock
 Packing: 1pc/bag, 20bag/box, 6box/carton

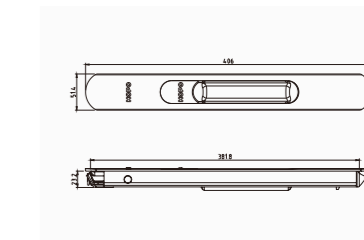



MA lock MAL433.** **Pull driver BH60.20**

Article No: MAL433.**.##
 Description: 433 MA lock_Fork length_Color
 Fork length: 25/30mm
 Surface treatment: Anodized/Power coating
 Application: Sliding door/window
 Packing: 1pc/bag, 15bag/box, 6box/carton

Article No: BH60.20.##
 Description: Pull driver_used with MAL433_Color
 Surface treatment: Anodized/Power coating
 Application: Sliding door/window, used with MA lock
 Packing: 1pc/bag, 20bag/box, 6box/carton

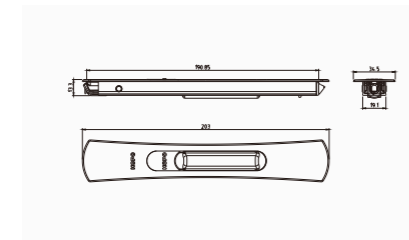
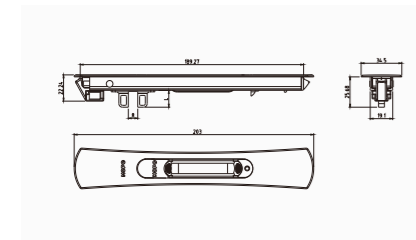

MA lock MAL422.** **Stock** **Pull driver BH422.10**

Article No: MAL422.**.##
 Description: 422 MA lock_With cylinder_Color
 Fork length: 21/25/30mm
 Surface treatment: Anodized/Power coating
 Application: Sliding door ,with cylinder
 Packing: 20pc/box, 120pc/carton (15pc/box, 90pc/carton)

Article No: BH422.**.##
 Description: 422 Pull driver_Without cylinder_Color
 Surface treatment: Anodized/Power coating
 Application: Sliding door ,with cylinder
 Packing: 1pc/bag, 20bag/box, 6box/carton

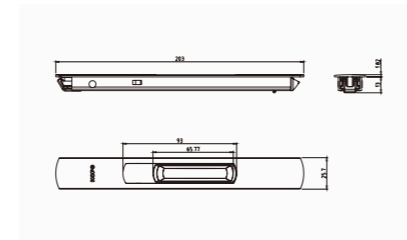
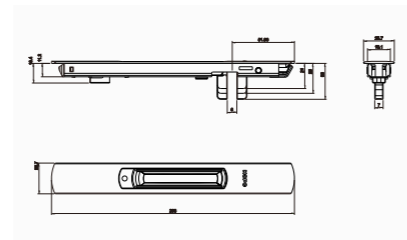

MA lock MAL438.** **Pull driver BH60.37**

Article No: MAL438.**.02C##
 Description: 438 MA lock_Fork length_ Universal key ,Color
 Fork length: 25/30mm
 Surface treatment: Anodized/Power coating
 Application: Sliding door/window
 Packing: 1pc/bag, 20bag/box, 6box/carton

Article No: BH60.37.##
 Description: Pull driver_Color
 Surface treatment: Anodized/Power coating
 Application: Sliding door/window, used with MA lock
 Packing: 1pc/bag, 20bag/box, 6box/carton

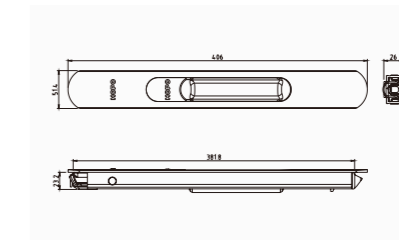
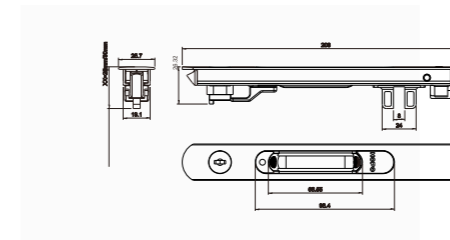

Heavy-Duty MA Lock



MA lock MAL426.**

Article No: MAL426.**.##
 Description: 426 MA lock_Fork length_Color
 Fork length: 30/37mm
 Surface treatment: Anodized
 Application: Sliding door
 Packing: 1pc/bag, 8bag/box, 5box/carton

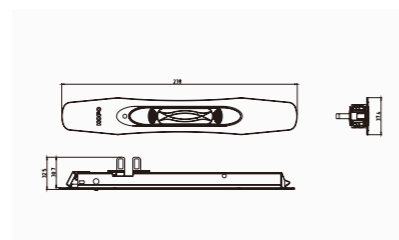

MA lock MAL426.10

Article No: MAL426.10.##
 Description: 426 MA driver_Normal_Color
 Surface treatment: Anodized
 Application: Sliding door, used with MA lock
 Packing: 1pc/bag, 10bag/box, 5box/carton

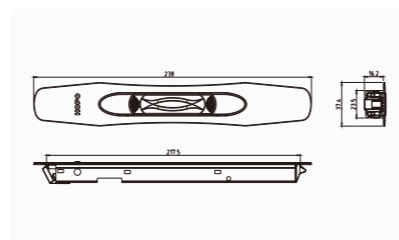

WINDOW AND DOOR



MA lock MAL426.**

Article No: MAL426.**.##
 Description: 426 MA lock_Fork length_Color
 Surface treatment: Anodized
 Application: Sliding door
 Fork length: 30/37mm
 Packing: 1pc/bag, 8bag/box, 5box/carton

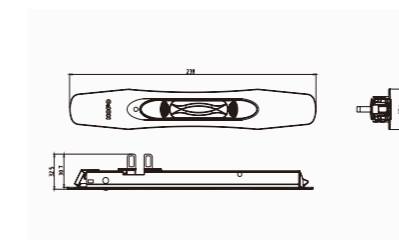

MA lock MAL426.20

Article No: MAL426.20.##
 Description: 426 MA driver_With cylinder_Color
 Surface treatment: Anodized
 Application: Sliding door, used with MA lock
 Packing: 1pc/bag, 10bag/box, 5box/carton

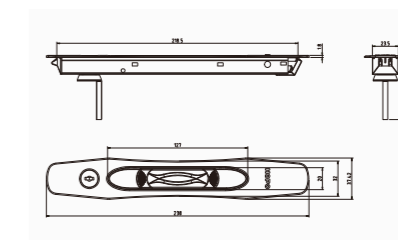





Luxury pull handle BH466

Article No: BH466.1X.##
Description: 466 pull handle_Inside, material_Color
Length: 284.57mm
Surface treatment: Anodized, Power coating
Application: Sliding door
Packing: 1pc/bag, 2bag/box, 6box/carton

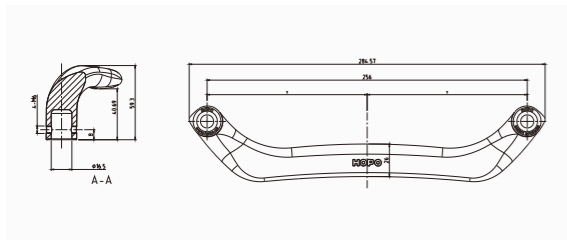

Luxury pull handle BH459

Article No: BH459.11.XX
Description: 459 pull handle_Inside, material_Color
Length: 341.4mm
Surface treatment: Anodized
Application: Sliding door
Packing: 1pc/bag, 2bag/box, 6box/carton

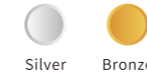
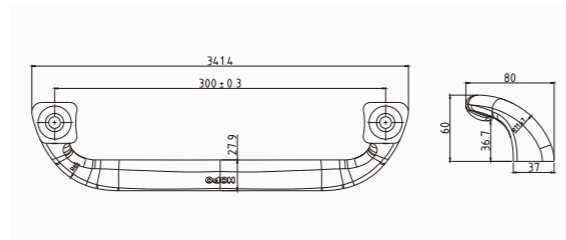

Luxury pull handle BH470

Article No: BH470.11.##
Description: 470 pull handle_Inside Aluminum oxide_Color
Length: 600mm
Surface treatment: Anodized
Application: Sliding door
Packing: 1pc/bag, 5bag/box, 4box/carton

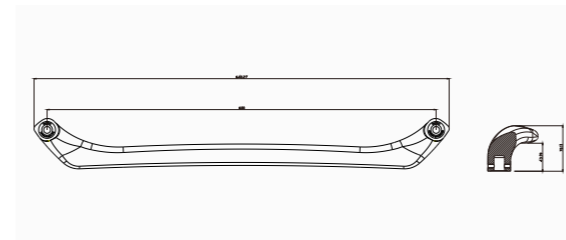

Luxury pull handle BH472

Article No: BH472.11.##
Description: 472 pull handle_Inside Aluminum oxide_Color
Length: 600mm
Surface treatment: Anodized
Application: Sliding door
Packing: 1pc/bag, 5bag/box, 4box/carton

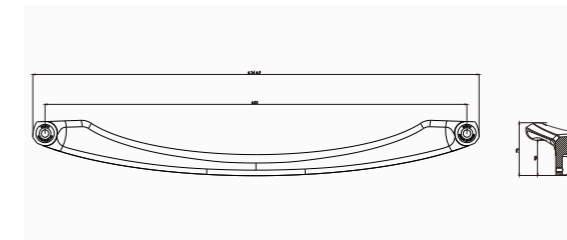

Luxury pull handle BH473

Article No: BH473.XX.##
Description: 473 pull handle_Length XXm_Color
Length: 1.5m/1.8m
Surface treatment: Power coating
Application: Sliding door
Packing: 2pc/carton

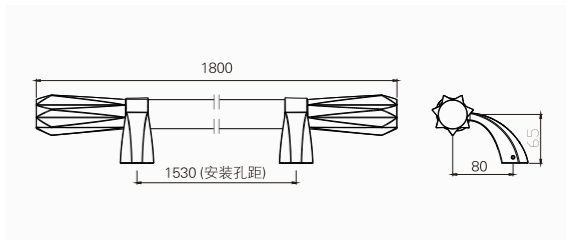

Light-duty locking plate



Transfer rod DR42+DR41+Heavy duty T-type connector TTC31

Article No:DR42.5007.12CXX
 Description:DR42 Transfer rod_500mm rod length_Locking pin diameter 7mm_12mm height

Article No:DR41.**07.12CXX
 Description:DR41 Transfer rod_**mm rod length_Locking pin diameter 7mm_12mm height

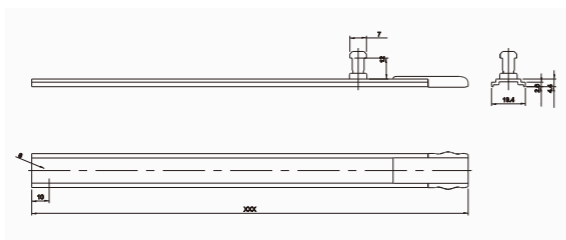
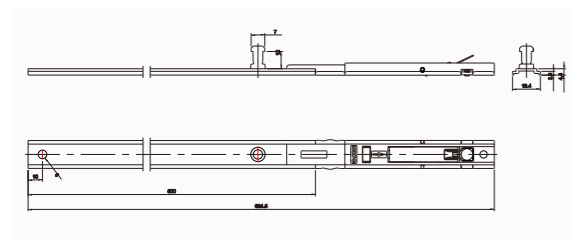

Transfer rod DR40.0807.14C066X+Heavy duty T-type connector TTC29

Article No:DR40.0807.XXC##
 Description:DR40 Transfer rod_800mm rod length_Locking pin diameter 7mm_Height_Black
 Material:Aluminium alloy
 Application:Sliding door
 Packing:2pc/bag,5bag/carton

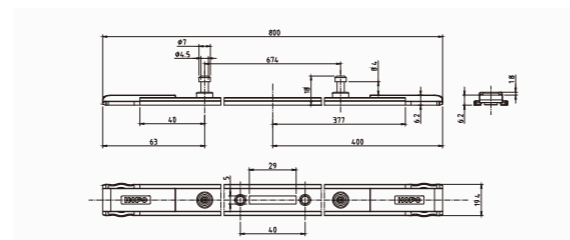

TTC31 Heavy duty T-type connector

Article No:TTC31.**.069X
 Description:Heavy duty T-type connector_Length_Black without logo
 Length:19/23/28/35/45/50/65mm
 Material:Zinc alloy, power coating
 Application:Sliding door/window
 Packing:40pc/box, 8box/carton(30pc/box, 8box/carton)

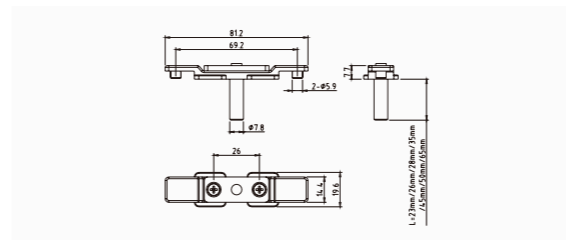

WINDOW AND DOOR

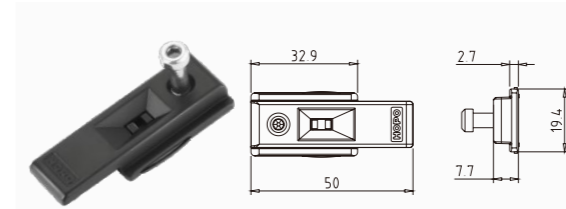

Sliding rod LPE45.07

Article No:LPE45.07.**C069
 Description:Heavy duty sliding rod_Locking pin diameter 7mm_Height_black
 Locking pin height:9.5/12/14/19mm
 Material:Zinc alloy
 Application:Sliding door/window

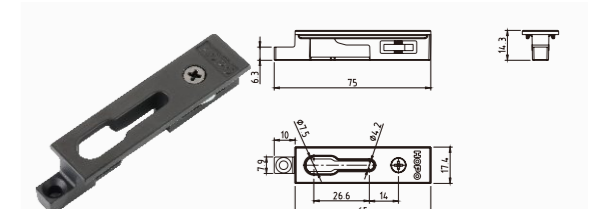

Locking plate SLP47.03

Article No:SLP47.03.069
 Description:Heavy duty sliding plate_Normal wholly concealed_Black
 Material:Zinc alloy
 Application:Sliding door/window
 Packing :40pc/box, 320pc/carton

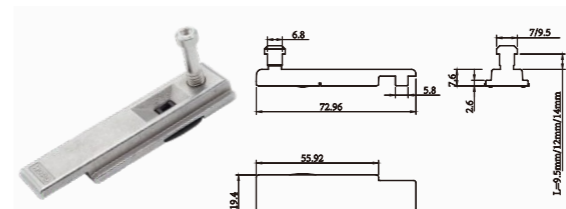

Sliding rod LPE46.07

Article No:LPE46.07.**C38H4
 Description: Sliding rod_Diameter 7mm_Height 19mm_Color
 Locking pin height:9.5/12/14/19mm
 Material:Stainless steel
 Application:Sliding door/window
 Packing:40pc/box, 8box/carton

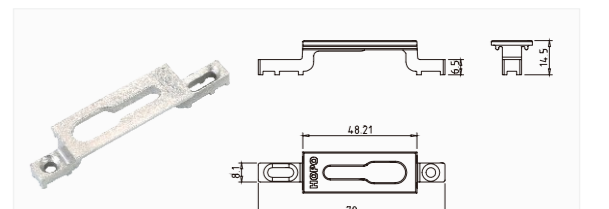

Locking plate SLP47.00

Article No:SLP47.00.38
 Description:Heavy duty sliding plate_Normal_Color
 Material:Zinc alloy/Stainless steel
 Application:Sliding door/window
 Packing :60pc/box, 480pc/carton

Heavy-duty locking plate



Transfer rod DR42+Heavy duty T-type connector TTC31

Article No:DR42.5095.12CXX
 Description:DR42 Transfer rod_500mm rod length_ Locking pin diameter 9.5mm_12mm height

Article No:DR41.**95.12CXX
 Description:DR41 Transfer rod_**mm rod length_ Locking pin diameter 9.5mm_12mm height

Transfer rod DR40.0895.14C066X+Heavy duty T-type connector TTC29

Article No:DR40.0895.XXC##
 Description:DR40 Transfer rod_800mm rod length_ Locking pin diameter 9.5mm_Height_Black
 Material:Aluminium alloy
 Application:Sliding door
 Packing:2pcs/bag,5bag/carton

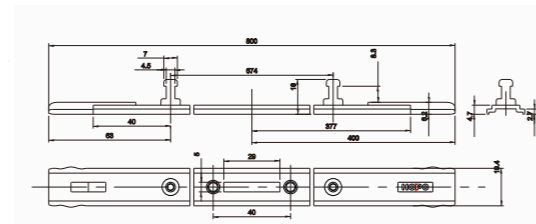
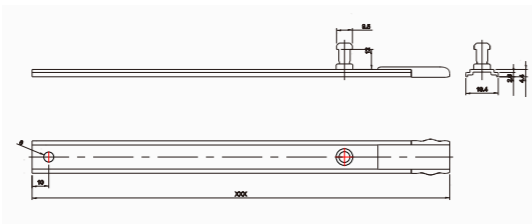
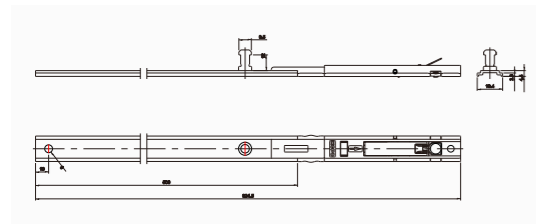

TTC31 Heavy duty T-type connector

Article No:TTC31.**.069X
 Description:Heavy duty T-type connector_Length_ Black without logo
 Length:Optional
 Material:Zinc alloy, power coating
 Application:Sliding door
 Packing:40pc/box, 8box/carton(30pc/box, 8box/carton)

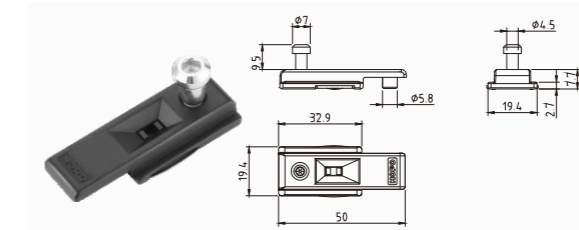
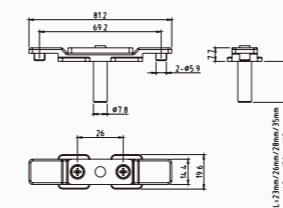

Sliding rod LPE45.95

Article No:LPE45.95.XXC069
 Description:Heavy duty sliding rod_Locking pin diameter 9.5mm_Height XXmm black
 Material:Zinc alloy
 Application:Sliding door

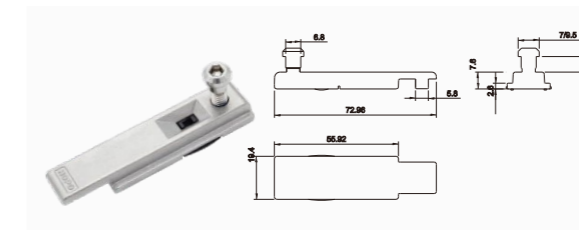

Sliding rod LPE46.95

Article No:LPE46.95.**C38H4
 Description: Locking rod_Diameter 9.5mm_Height_Color
 Locking rod height:12/15/19mm
 Material:Stainless steel
 Application:Sliding door
 Packing :40pc/box, 8box/carton

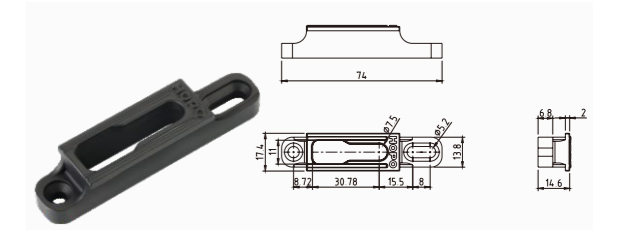

Locking plate SLP42.01

Article No:SLP42.01.069
 Description:Heavy duty sliding plate_New design half concealed_ Black
 Material:Zinc alloy
 Application:Sliding door
 Packing :60pc/box, 480pc/carton

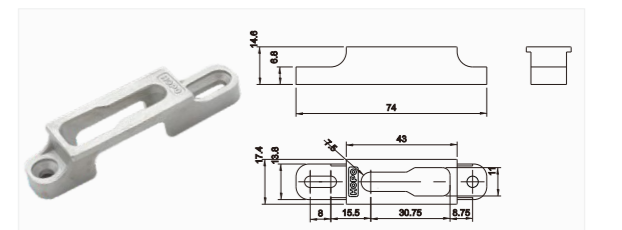

Locking plate SLP42.02

Article No:SLP42.02.38
 Description:Heavy duty sliding plate_New design _ Color
 Material:Stainless steel
 Application:Sliding door
 Packing :10pc/box, 480pc/carton

Heavy-Duty Lock



Sliding double-hook short lock

Article No:SDT46.28.22C
 Description:Sliding double-hook short lock_Center distance 28mm_Panel width 22mm
 Material:Stainless steel
 Application:Sliding door
 Packing:1pc/box, 20pc/carton

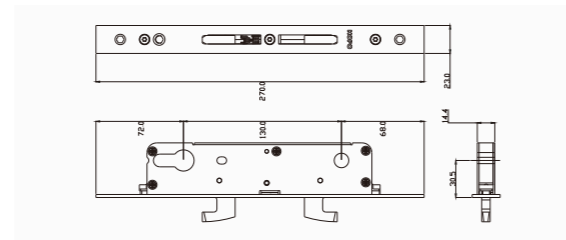

SLP48.03 Heavy-duty locking plate

Article No:SLP48.03.069
 Description:Double-hole locking plate_Normal_Color
 Material:Zinc alloy
 Application:Sliding door
 Packing:20pc/box, 100pc/carton

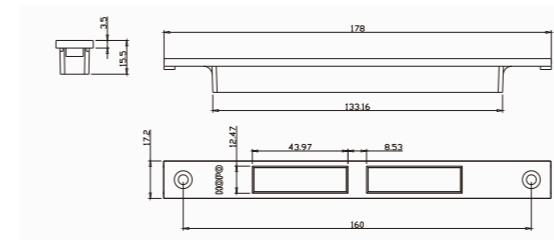

C99 Cylinder Stock

Article No:C99.XXXXC##
 Description:C99 cylinder_A size B size_Color
 Material:Copper
 Application:Sliding door, casement door, folding door
 Packing:1pc/box, 50pc/carton(1pc/box, 45pc/carton)

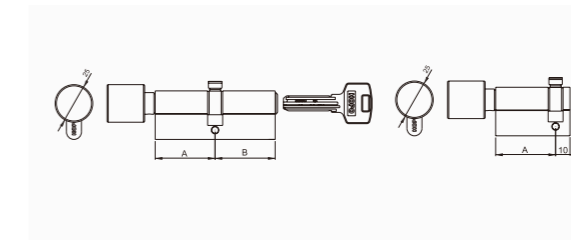

CC53 Cylinder cover Stock

Article No:CC53.####
 Description:CC53 cylinder cover_Color
 Color:Silver, bronze,black,white,gilded
 Material:Aluminium,stainless steel
 Application:Sliding door, casement door
 Packing:50set/box, 250set/carton

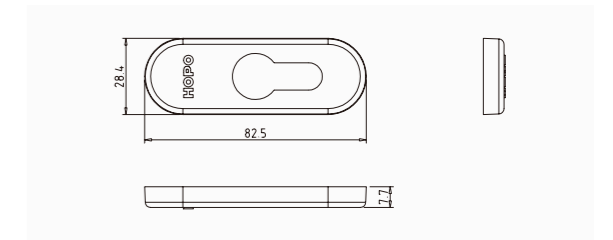

Roller

Height conveniently adjustable, smooth movement.



WINDOW AND DOOR



R03 Roller

Article No:R03.232305.07H5
Description:03 roller_Width 23mm ,Min. Height 23mm, adjustable height 5mm
Material:Stainless steel(White wheel)
Load bearing capacity:90kg
Packing:1pc/bag, 80pc/carton

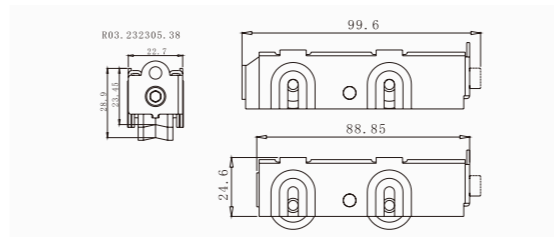

R08 Roller

Article No:R08.122207.07H5
Description:08 roller_Width 12mm ,Min. Height 22mm, adjustable height 7mm
Material:Stainless steel(White wheel)
Load bearing capacity:90kg
Packing:20pc/box, 100pc/carton

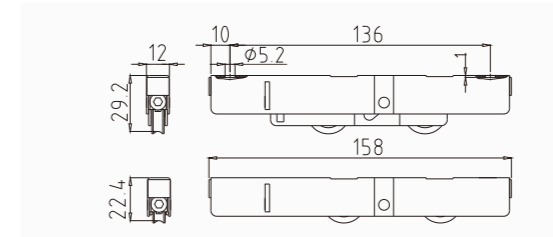

R13 Roller

Article No:R13.163107.07H5
Description:13 roller_Width 16mm ,Min. Height 31mm, adjustable height 7mm
Material:Stainless steel(White wheel)
Load bearing capacity:200kg
Packing:1pc/bag, 30pc/carton

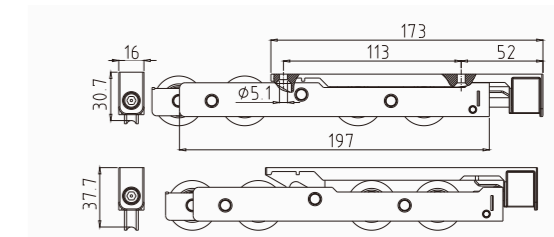



R15 Roller

Article No:R15.122305.07H5
 Description:15 roller_Width 12mm ,Min. Height 23mm, adjustable height 5mm
 Material:Stainless steel(White wheel)
 Load bearing capacity:150kg
 Packing:1pc/bag, 60bag/carton

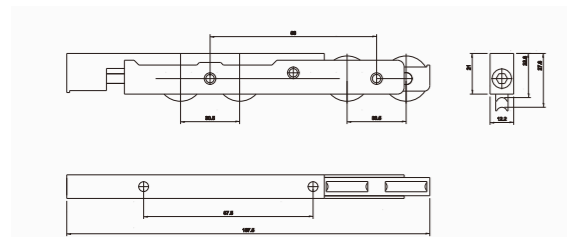

R18 Roller

Article No:R18.152507.07H5
 Description:18 roller_Width 15mm ,Min. Height 25mm, adjustable height 7mm
 Material:Stainless steel(White wheel)
 Load bearing capacity:100kg
 Packing:15pc/box, 60pc/carton

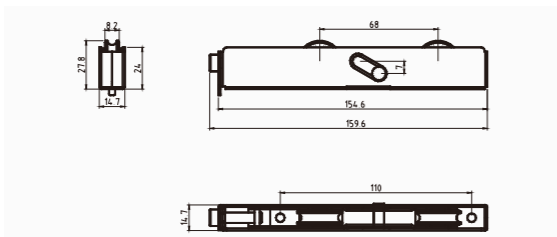

R19 Roller

Article No:R19.163107.07H5
 Description:19 roller_Width 16mm ,Min. Height 31mm, adjustable height 7mm
 Material:Stainless steel(White wheel)
 Load bearing capacity:130kg
 Packing:1pc/bag, 20bag/box,5box/carton

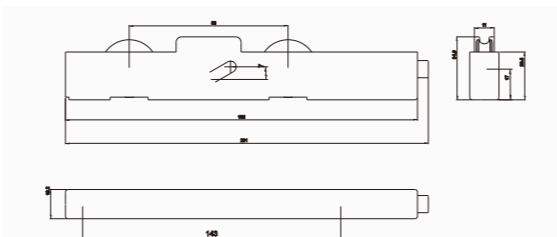

R21 Roller Stock

Article No:R21.224415.38
 Description:21 roller_Width 22mm ,Min. Height 44mm, adjustable height 15.5mm
 Material:Stainless steel(White wheel)
 Load bearing capacity:300kg
 Packing:1pc/bag, 20bag/carton

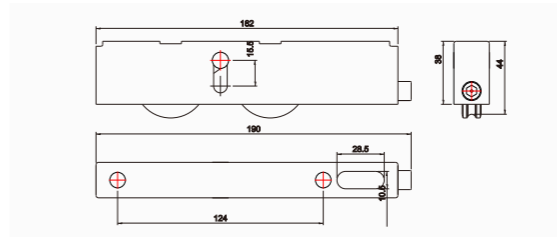

R25 Roller

Article No:R25.152305.07H5
 Description:25 roller_Width 15mm ,Min. Height 23mm, adjustable height 5mm
 Material:Stainless steel(White wheel)
 Load bearing capacity:90kg
 Packing:1pc/bag, 20bag/box, 4box/carton

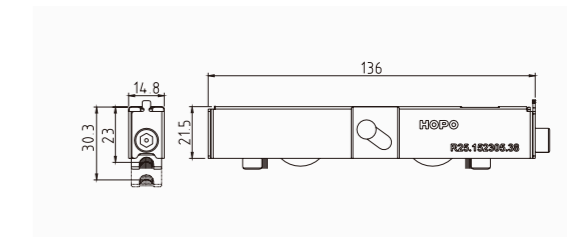

65 Bi-Folding System Solutions



Roller components ABR65.40 **Stock**

Article No: ABR65.40

Description: N65 folding roller_Regular_Color

Surface treatment: Anodized

Application: 65 folding door

Packing: 1set/bag, 6set/carton

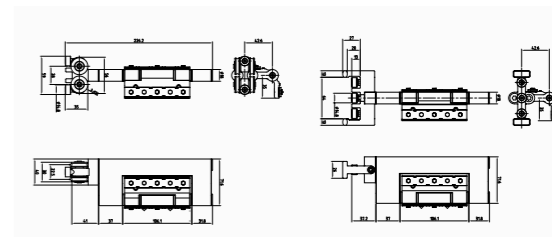



Hinge components ASH65.03 **Stock**

Article No:ASH65.03
 Description: N65 folding hinge_Regular_Color
 Surface treatment:Anodized
 Application:65 folding door
 Packing:6pc/box, 30pc/carton

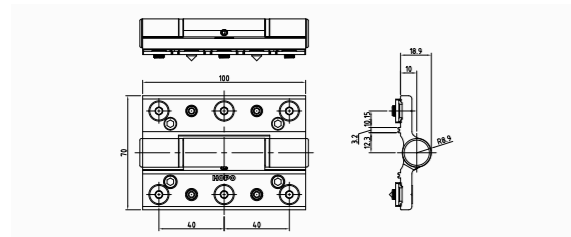

Pull driver AHH65 **Stock**

Article No:AHH65.##
 Description:N65 folding hinge pull driver_Color
 Surface treatment: Anodized/powder coating
 Color: Silver/Black
 Material: Zinc alloy
 Single sash load bearing :90KG
 Application:65 series folding windows and doors
 Packing:6pc/box, 30pc/carton

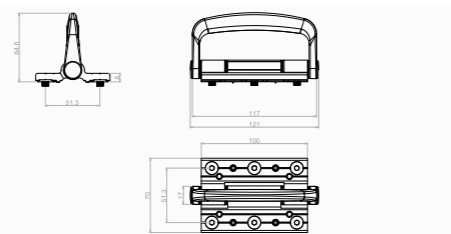

Leaf catcher TBL65.01X **Stock**

Article No:TBL65.XX
 Description:N65 folding leaf catcher_Color
 Color:Silver/Black/White
 Material:Nylon
 Application:65 series folding door
 Packing:20set/box, 100set/carton

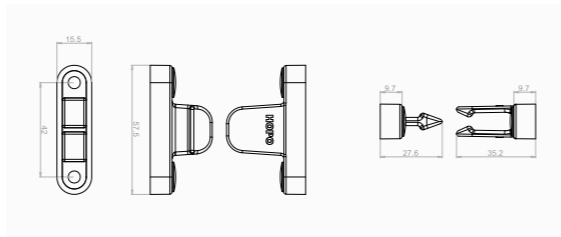

Gear case AGC65.14 **Stock**

Article No:AGC65.14.##
 Description:65 gear case_14mm Center distance_Color
 Material:Zinc alloy
 Application:65 series folding systems
 Packing:15pc/box, 60pc/carton

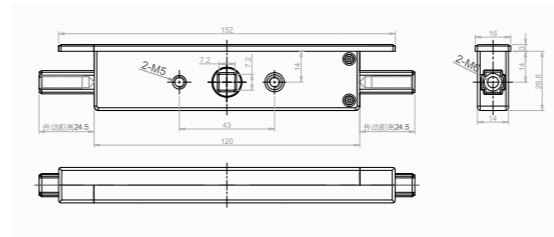

PH171 Handle **Stock**

Article No:PH171.00.##
 Description:PH171 handle_No spindle_Color
 Spindle length:Without spindle, match SP07 spindle
 Color:Silver/Bronze/Dark bronze/Black
 Material:Aluminium alloy
 Surface treatment:Anodized
 Application:Folding doors or double sash windows
 Packing:5pc/box, 40pc/carton

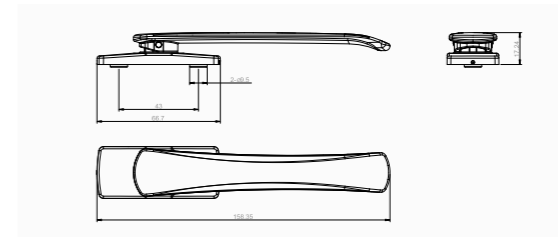

Shoot bolt ASB60.00/ASB65.10 **Stock**

Article No:ASB65.XX.##
 Description:65 Shoot bolt_Regular/New design_Black
 Material:POM
 Application:65 Folding windows and doors
 Packing:40set/box, 200set/carton
 (15set/box,75set/carton)

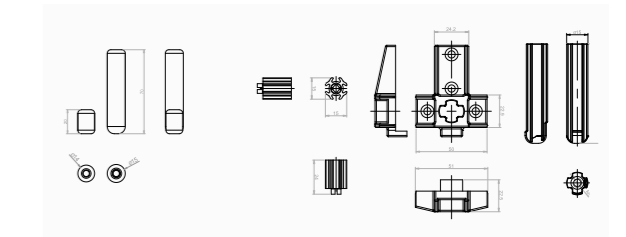



Double-side door handle sets HSD633 Stock

Article No:HSD633.XXXX
 Description:633 Double-side door handle sets_Color
 Color:Silver/Bronze/Black/White/Dark bronze
 Material:Aluminium alloy
 Installation hole:91.5mm,118.5mm
 Surface treatment:Anodized/Power coating
 Application: Casement doors,folding doors
 Packing:1set/box, 10set/carton

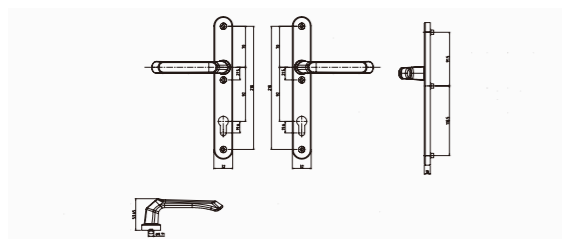

Mortise lock SDL51.32

Article No:SDL51.**.22C38
 Description:22 mortise lock_Center distance 32mm_
 Panel width 22mm
 Center distance:27/32mm
 Material:Stainless steel
 Application: C /K groove profiles of European standard
 Packing:1pc/box, 20pc/carton

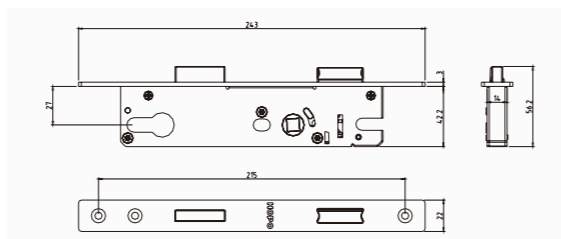

C99 Cylinder Stock

Article No:C99.4545C4T029
 Description:C99 cylinder_A size B size_Color
 Color:Gilded/Pearl Chrome
 Material:Copper
 Application: Sliding door, casement door, folding door
 Packing:1pc/box, 50pc/carton

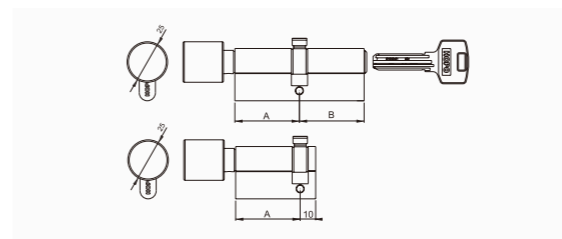

Locking plate ALPD50.07

Article No:ALPD50.07.38
 Description:Adjustable locking plate_No distinction
 between left and right_Color
 Material:Stainless steel
 Application: Casement/folding door for C groove
 Packing:14pc/box, 70pc/carton

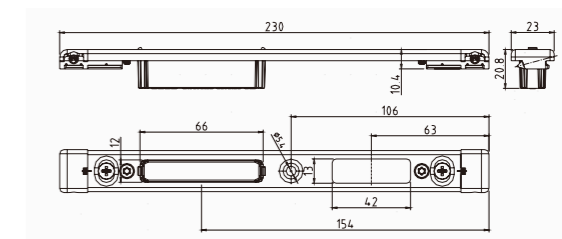

LIFE ART AT FINGERTIPS
Rosette Free Handle

PH312

Special design intensifies aesthetic appearance
Pleasing sound emitted when turning the handle.
Fixed holes structure makes installation stable
Handle operation through 90° intervals
Smooth operation.
The Installation is simple and fast:
the only requirement is to tighten screws!



LIFE ART AT FINGERTIPS
Rosette Free Handle

PH313

Special design intensifies aesthetic appearance
Pleasing sound emitted when turning the handle.
Fixed holes structure makes installation stable
Handle operation through 90° intervals
Smooth operation.
The Installation is simple and fast:
the only requirement is to tighten screws!



TWO-WAYS
Gear Case

AGC37



Two-way transmission, the cover is in aluminum with anodized finish, minimal and pleasing to the eye. New gear case does not require screws: easier installation. Profile milling not required.

Available in various center distances: 00mm, 13mm, 23mm, 30mm, 35mm.

90° rotation
Suitable for rosette free handle and normal handle
No additional accessory bag is required to install the rosette free handle.

LIFE ART AT FINGERTIPS

Anti-Prying Locking Rod

ALR28



Used in Multi-point lock solution: the locking pin comes with rolling mechanism to match the anti-pry locking plate, which has higher security performance. The roller absorbs the sliding friction between the locking pin and the locking plate, reduces friction significantly, increases product life and improves the operating experience



SDLK50

LIFE ART AT FINGERTIPS

Safety Series Mortise Lock

The Safety series mortise lock has a safety function: the cylinder-lock controls the reach of locking tongue to open/close the door sash.

When the handle is turned upwards, the connecting rod is driven downwards, the knob rotates and the square tongue is stretched out to reach complete locking;

The extension of the square tongue is controlled within 11mm so that will not touch the top frame. No holes are required to be drilled during installation

The 'Safety Series' Mortise Lock is simplified: the 6mm cylindrical connecting PIN is built-in the two connecting rods (previous 2 zinc alloy transfer rods no more required), making installation more convenient;

Stainless steel panel stamping and wire drawing process have a proven anti-corrosion capacity.

It has passed professional tests (open and close repeatedly 100,000 times, pass the 30N/m torque test) without meeting any irregularity. It also has a long lifespan.



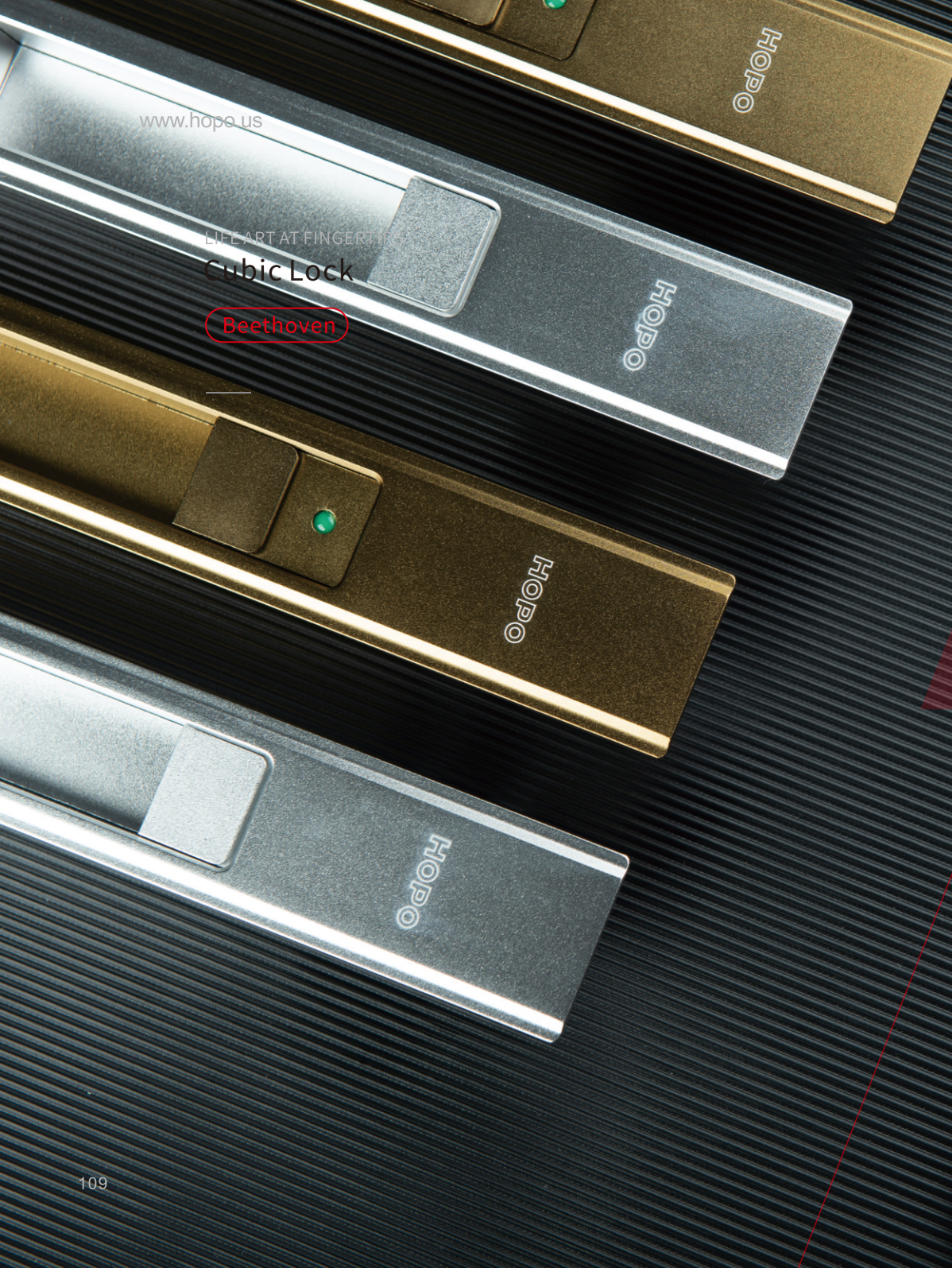

www.hopo.us

LIFE ART AT FINGERTIPS
Cubic Lock

Beethoven



WINDOW AND DOOR

LIFE ART AT FINGERTIPS
Cubic Lock

Beethoven

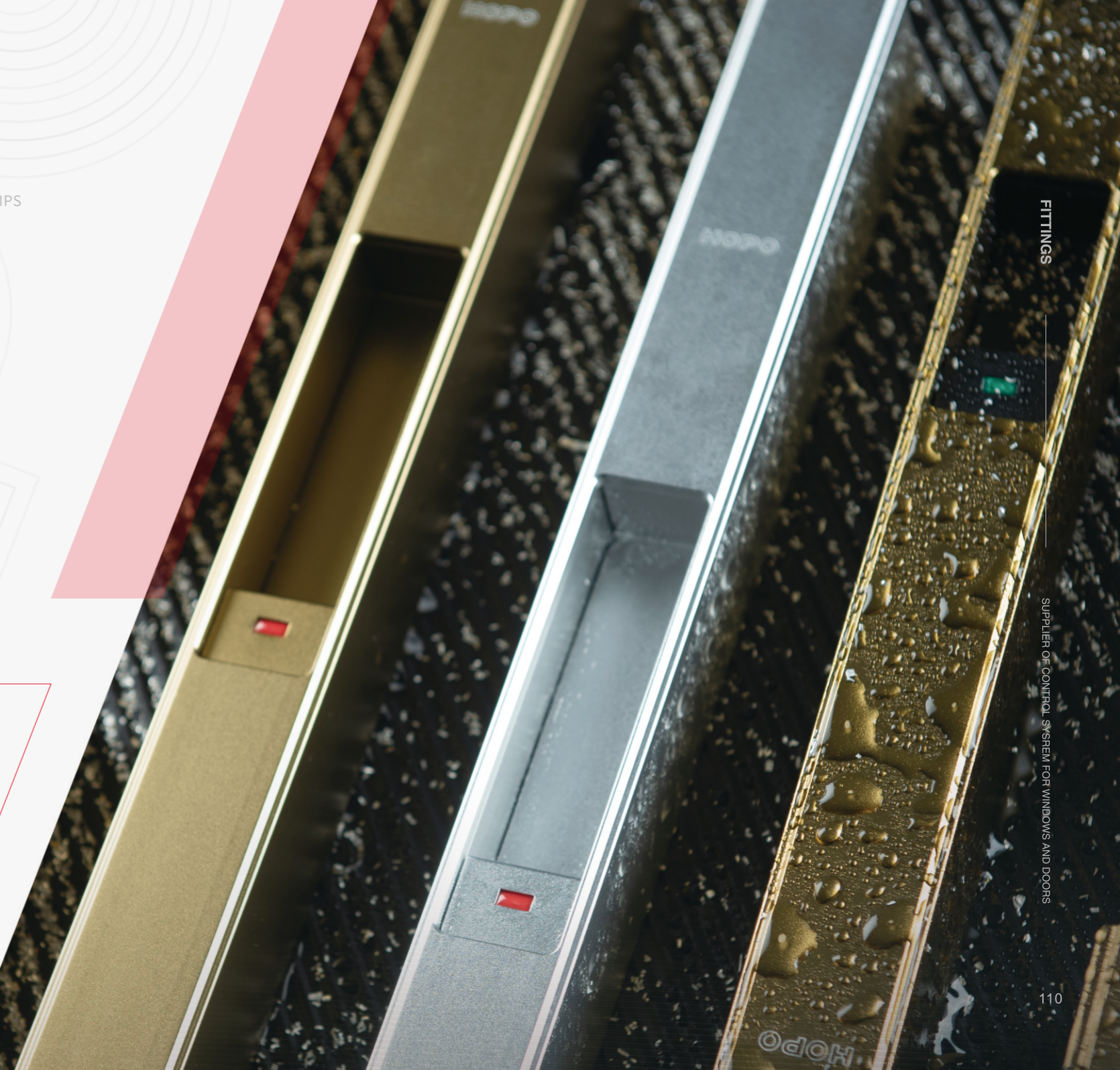

FITTINGS

SUPPLIER OF CONTROL SYSTEM FOR WINDOWS AND DOORS

Antibacterial handle
Antibacterial Handle

Left **PH312** Right **PH313**

Standard setter of antibacterial handle, opening a new era of antibacterial handles. It has passed the national laboratory antibacterial test and also the United States Intertek Testing certification



Antibacterial handle
Antibacterial Door Handle Set

HSD605



Brochure instructions

This brochure provides references for users to select products, please read it carefully. If you have any question, please contact us.

1. Article number description

For example: fork handle AH 25 . ** . ## . HX

AH	25	**	##	HX
Abbreviations of products	Product series	**Product specification	##Color optional	X logo type
C-Cylinder	25 29	22 25 35 40	04-Anodized bronze	H1: HOPO standard logo
R-Roller	402 408	45 50 55 60	043-Powder coating bronze	H2: HOPO laser logo
AH-Fork handle	500 501 502		011-Anodized Silver	H3: HOPO silk-screen logo
PH-Square spindle handle	702		012-Powder coating silver	H4: HOPO customized logo
FH-Friction hinge			042-Anodized dark bronze	H5: HOPO embossed logo
AGC-Gear case			044-Powder coating dark bronze	
ATR-Open stay			066-Anodized Black	
MAL-MA lock			069-Powder coating black	
AMH-Hinge			01-White plastic	
ABH-Column Hinge			06-Black plastic	
HSD- Door handle set			07-Powder coating white	
SDL-Mortise Lock			027-Gold-plate	
ALPD-Adjustable door locking plate			021-Electroplated	
CATH-Conceal hinge			031-Electroplated black	
			045-Anodized dark bronze (New)	

2. Dimension of square spindle handle

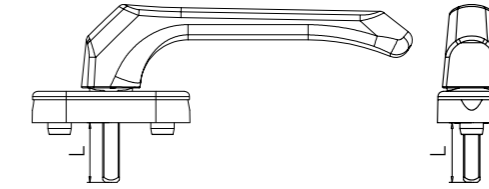

Description	Article No	Note
Square spindle handle	PH108.**.011	**Means spindle length, length is optional

3. Dimension of fork handle

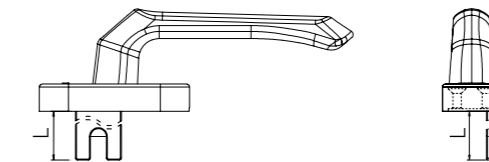

Description	Article No	Note
Fork handle	AH29.**.011	** Means spindle fork, length is optional

4. Dimension of gear case back set

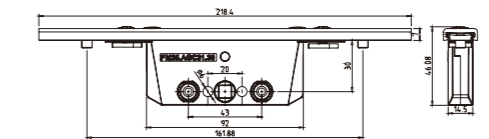

Description	Article No	Note
Gear case	AGC31.30.1T011	The center distance dimension of gear case:30mm Hole spacing:43mm

5. Dimension of mortise lock back set

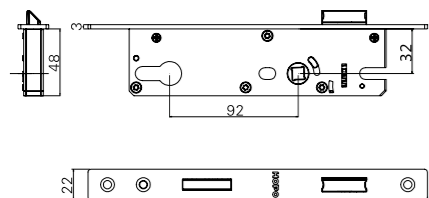

Description	Article No	Note
Mortise lock SDL51.32.22C38		Back set:32mm
Center distance 92mm, square spindle 8*8m, flat width of Mortise lock 22mm , thickness:3mm		

6. Dimension of Adjustable roller

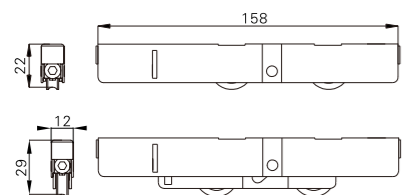

Description	Article No	Note
Roller	R08.122207.07H5	Width:12mm, Minimum height: 22mm, Adjustable height : 7mm

7. Dimension of deluxe pull handle

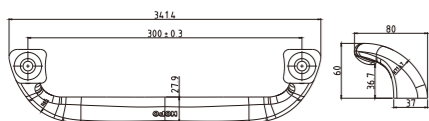

Description	Article No	Note
Deluxe Pull handle	BH459.11.**	Aluminum oxide

8. MA lock adjustable function description

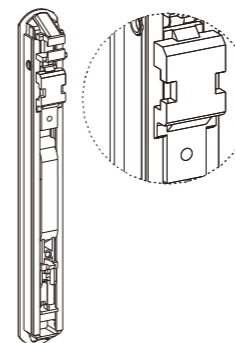

Semi-automatic function
Springs and screws are not built in. After the door is opened, the MA lock needs to be manually reset. When the door is being closed, it is locked automatically.

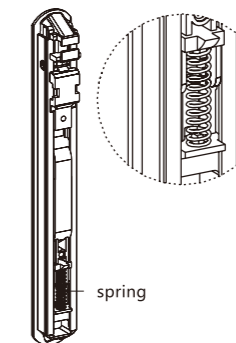

Fully automatic function
Only the spring is built-in: the MA lock does not need to be manually reset after the door is opened; the sash is automatically locked when the door is being closed.

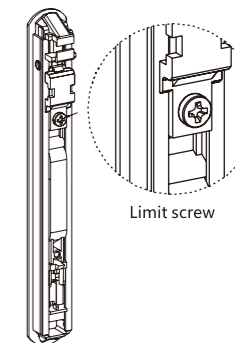

Manual function
Only the limit screw is built-in. After the door is opened, the MA lock needs to be manually reset. When the door is being closed, it is locked manually.

9. Friction hinge dimensions

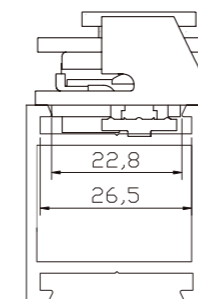

K groove friction hinge FH07

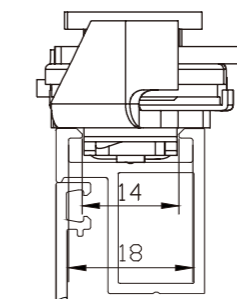

C groove friction hinge FH06

10. Cylinder specification

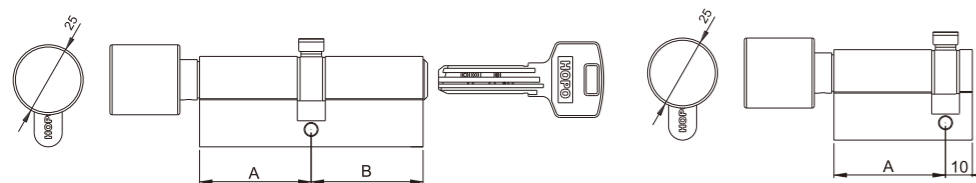

No.: C99.ABC4T029 Specification: A/B (side of the knob/side of the cylinder)

A size optional	B size optional	Description
	00	Half cylinder
25	25	Normal
30	30	Normal
35	35	Normal
40	40	Normal
45	45	Normal
50	50	Normal
55	55	Normal



For example: C99.3045C4T029 means – side of the knob/side of the cylinder; A size:30mm, B size:45mm

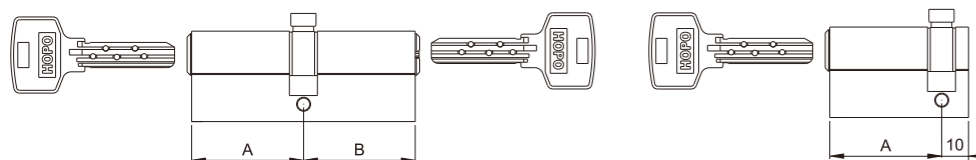

No.: C98.ABC029 Specification A/B double key (Open together) cylinder

A size optional	B size optional	Description
	00	Half cylinder
25	25	Normal
30	30	Normal
35	35	Normal
40	40	Normal
45	45	Normal
50	50	Normal
55	55	Normal



For example: C98.3045C029 means both sides have key cylinder A size : 30mm, B size:45mm.